

STABILIMENTO PRODUTTIVO
Via Alfredo Fieramonti (Zona Industriale)
04012 Cisterna di Latina (LT)
Tel: +39.06.9680943
Fax: +39.06.9680948
Web: www.legnobagno.it
Email: info@legnobagno.it

COMPONIBILE_4
Urban

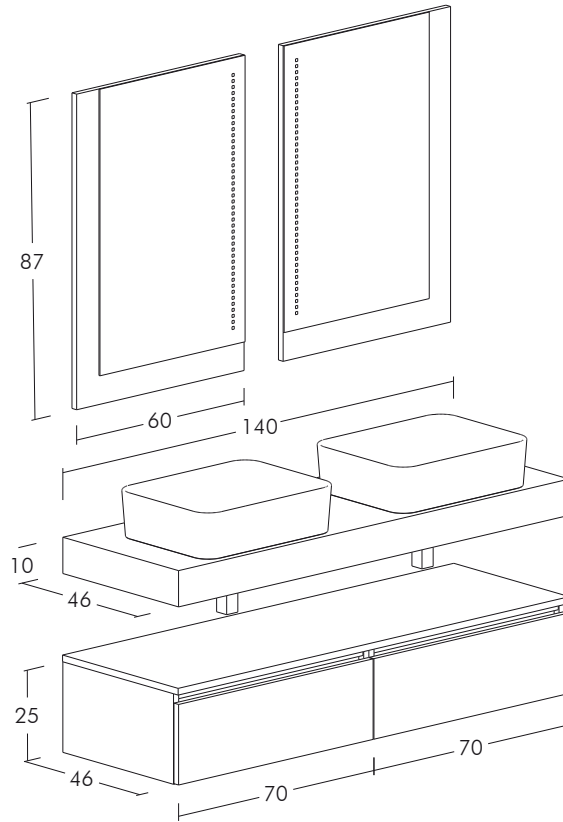

SCHEDA TECNICA
TECHNICAL SHEET

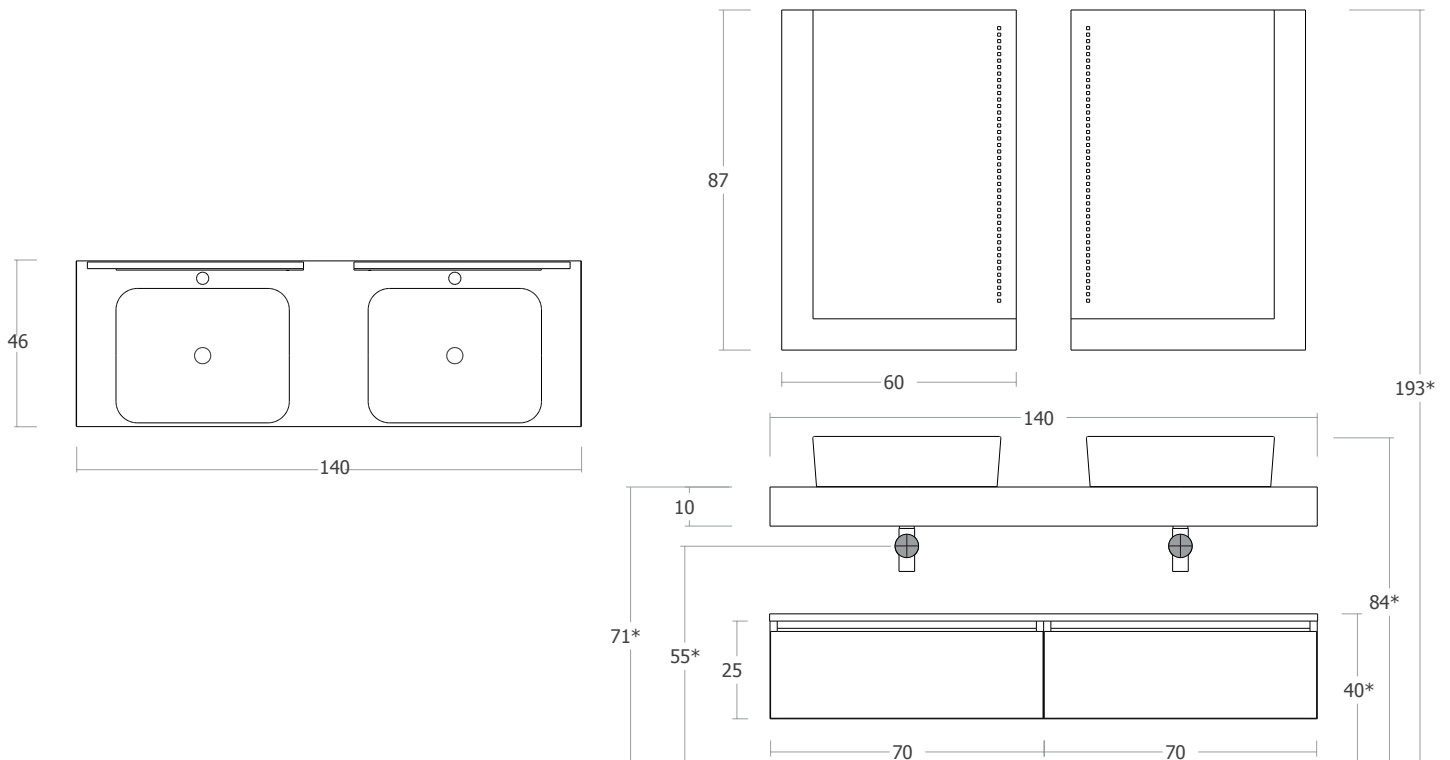

*quote di installazione consigliate
*assembly dimensions recommended