

LEGGNOBAGNO



COMPONIBILI

RETRO'

Retrò



L'intramontabile passione per il legno, si esprime nella collezione Retrò in diverse forme e diventa all'occorrenza tradizionale, minimalista, sobria...

The timeless passion for wood is expressed in the Retrò collection in different shapes and, if needed, becomes traditional, minimalist, understated...

LEGNOBAGNO



R 208
R 208



R 208

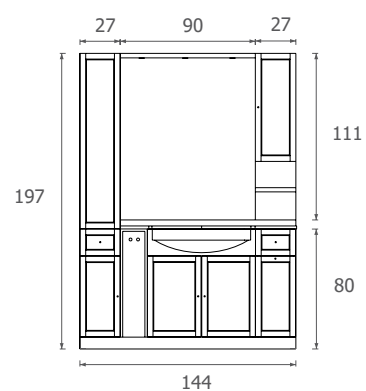

Colore composizione:
Noce (Finitura di base).
Top in marmo:
Marmo bianco polare.
Ante e cornici:
Massello di rovere.
Panciotto in legno:
Pannelli di multistrato curvato impiallacciato rovere.
Strutture interne:
Pannelli idrorepellenti W100 categoria "A".

Composition colour:
Walnut (Basic finish).
Marble top:
Polar white marble.
Doors and frames:
Solid oak.
Wooden vest:
Oak veneered curved multilayer panels.
Internal structures:
Category "A" W100 water-resistant panels.





R 209
R 209



R 209

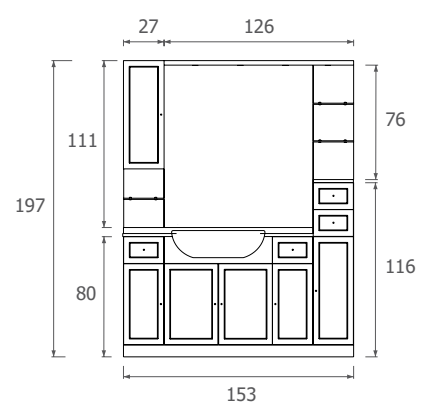

Colore composizione:
Bianco lucido (Finitura speciale).
Top in marmo:
Marmo Carrara.
Ante e fianchi:
Pannello MDF e idrorepellente W100 categoria "A".
Strutture interne:
Pannelli idrorepellenti W100 categoria "A".

Composition colour:
Brilliant white (Special finish).
Marble top:
Carrara marble.
Doors and sides:
Category "A" W100 water-resistant and MDF panels.
Internal structures:
Category "A" W100 water-resistant panels.



R 210
R 210



R 210

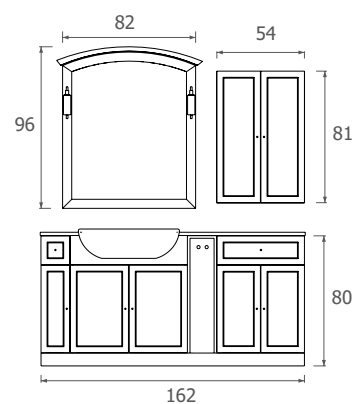

Colore composizione:

Sabbia antico (Finitura speciale).

Top in marmo:

Marmo Travertino.

Ante e fianchi:

Pannello MDF e idrorepellente W100 categoria "A".

Strutture interne:

Pannelli idrorepellenti W100 categoria "A".

Composition colour:

Antique sand (Special finish).

Marble top:

Travertino marble.

Doors and sides:

Category "A" W100 water-resistant and MDF panels.

Internal structures:

Category "A" W100 water-resistant panels.





R 201
R 201



R 201

Una nuova possibilità nel programma Retrò, è data dall'inserimento dei portlavabi con frontali curvi estraibili. Ne risulta che anche questa linea si avvale di sistemi più evoluti. Gradevole l'effetto azzurro cielo decapè. La proposta si avvale del sistema sottopiano con lavabo universale e top in marmo carrara.

A new possibility in the Retrò program, is given by the insertion of washbasin units with sliding curved fronts. This line also uses the more advanced systems. Pleasant decapè sky blue effect. The proposal uses the undercounter system with universal washbasin and carrara marble top.

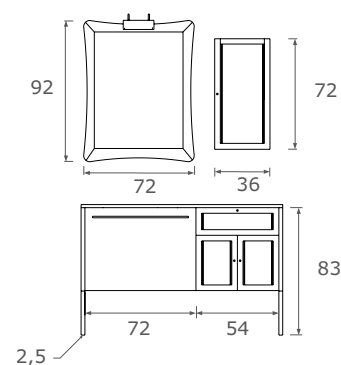

Colore composizione:

Decapè Azzurro cielo (Finitura speciale).

Top in marmo:

Marmo bianco Carrara per lavabo sottopiano universale.

Ante, fianchi e cornice specchio:

Massello di rovere.

Cassettone curvo:

Multistrato impiallacciato con legno di rovere.

Strutture interne:

Pannelli idrorepellenti W100 categoria "A".

Composition colour:

Sky blue decapè (Special finish).

Marble top:

Carrara white marble for universal undercounter washbasin.

Doors, sides and mirror frame:

Solid oak.

Curved large drawer:

Veneered multilayer with oak wood.

Internal structures:

Category "A" W100 water-resistant panels.



R 202
R 202



R 202 Armonico connubio di tratti moderni con il calore del legno, messo in evidenza dalla particolare bellezza della finitura patinata, che lascia a nudo tutte le sue caratteristiche naturali.

Harmonious combination of modern outlines with the warmth of wood, highlighted by the particular beauty of the glossy finish, which leaves all its natural features bare.

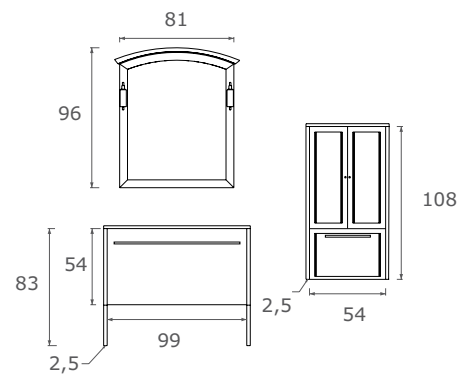

Colore composizione:

Rovere sbiancato patinato (Finitura speciale).

Top in marmo:

Marmo starlight ruby per lavabo sottopiano "Luna".

Ante, fianchi e cornice specchio:

Massello di rovere.

Cassettone curvo:

Multistrato impiallacciato con legno di rovere.

Strutture interne:

Pannelli idrorepellenti W100 categoria "A".

Composition colour:

Glossy whitened oak (Special finish).

Marble top:

Starlight ruby marble for the "Luna" undercounter washbasin.

Doors, sides and mirror frame:

Solid oak.

Curved large drawer:

Veneered multilayer with oak wood.

Internal structures:

Category "A" W100 water-resistant panels.

Il lavabo Luna si innesta sotto al top Starlight Ruby sovrastando il comodo cassettone ad estrazione totale.

The Luna washbasin fits under the Starlight Ruby top above the comfortable and fully removable large drawer.



R 203
R 203



R 203 Volumi ampi e tonalità cromatiche di contrasto, tra il top argenteo e la colorazione del legno. Il Rovere moro, abbinato all'anta classica del Retrò è una novità, che non passa inosservata. Notevole l'effetto ottenuto con il lavabo "Sfera Ovale" inserito nel top in cristallo argenteo. Di grande importanza la tecnologia "blum" adottata per questo modello nell'uso dei sistemi di scorrimento dei cassetti.

Wide volumes and contrasting chromatic shades, between the silver top and the colour of the wood. The dark oak, combined with the classic door of Retrò is a novelty, that does not go unnoticed. Impressive effect obtained with the "Sfera Ovale" washbasin inserted in the silver crystal top. Significantly important is the "blum" technology adopted for this model in the use of sliding systems for the drawers.

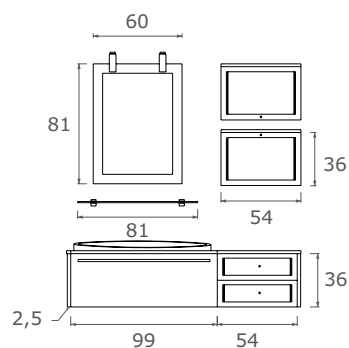

Colore composizione:
Rovere moro (Finitura speciale).
Top in vetro:
Cristallo extrachiaro colore argenteo per lavabo appoggio "Sfera 80".
Ante, fianchi e cornice specchio:
Massello di rovere, vetro fuso decorato.
Cassettoni curvo:
Multistrato impiallacciato con legno di rovere.
Strutture interne:
Pannelli idrorepellenti W100 categoria "A".

Composition colour:
Dark oak (Special finish).
Glass top:
Silver extra clear crystal for washbasin "Sfera 80" surface-mounted.
Doors, sides and mirror frame:
Solid oak, decorated melted glass.
Curved large drawer:
Veneered multilayer with oak wood.
Internal structures:
Category "A" W100 water-resistant panels.





R 204
R 204



R 204

Elegante fusione di elementi che generano uno stile molto raffinato e un comfort assoluto nella praticità quotidiana. Particolare cassetto: moderna tecnologia applicata a stili tradizionali, permette ottimali utilizzi dello spazio. Di grande effetto il lavabo "Sfera Tondo" semincassato nel top in travertino sagomato.

Elegant merging of elements that generate a very refined style and absolute comfort in every day's practicality. Drawer particular: modern technology applied to traditional styles, allows excellent use of space. Greatly effective is the "Sfera Tondo" washbasin semi-recessed in the shaped travertine top.

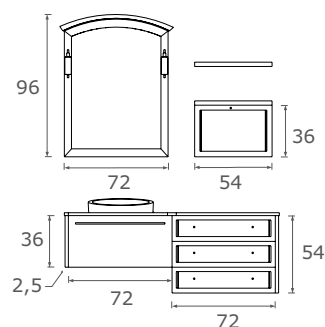

Colore composizione:
Bianco avorio decapè (Finitura speciale).
Top in marmo:
Marmo travertino anticato per lavabo appoggio "Sfera 40".
Ante, fianchi e cornice specchio:
Massello di rovere.
Cassetto curvo:
Multistrato impiallacciato con legno di rovere.
Strutture interne:
Pannelli idrorepellenti W100 categoria "A".

Composition colour:
Ivory white decapè (Special finish).
Marble top:
Antiqued travertine marble for "Sfera 40" surface-mounted washbasin.
Doors, sides and mirror frame:
Solid oak.
Curved large drawer:
Veneered multilayer with oak wood.
Internal structures:
Category "A" W100 water-resistant panels.





R 204

Di rilievo in questa composizione l'aspetto sobrio dell'insieme dato dall'accostamento "esplosivo" dei vari componenti, messi in risalto dalla finitura "luminosa" del bianco decapè.

Significant in this composition, is the understated aspect of the set given by the "exploded" combination of the various components, highlighted by the "luminous" finish of the decapè white.





R 206
R 206



R 206 Una seconda interpretazione del componibile ad angolo. La colorazione rovere moro sul massello esprime ancor meglio la sua forte intensità cromatica. Notare il risalto e la funzionalità nella disposizione degli specchi.

A second interpretation of the modular corner. The dark oak colour on the solid wood expresses even better its strong chromatic intensity. Note the relief and functionality in the disposition of the mirrors.

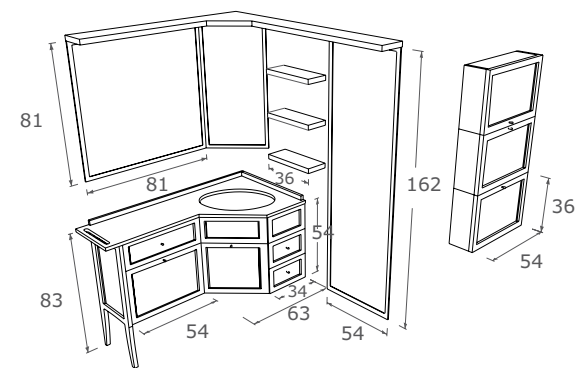

Colore composizione:
Rovere moro (Finitura speciale).
Top in marmo:
Marmo tecnico savana per lavabo sottopiano universale.
Ante, fianchi e cornice specchio:
Massello di rovere.
Strutture interne:
Pannelli idrorepellenti W100 categoria "A".

Composition colour:
Dark oak (Special finish).
Marble top:
Beige technical marble for universal undercounter washbasin.
Doors, sides and mirror frame:
Solid oak.
Internal structures:
Category "A" W100 water-resistant panels.





R 207
R 207



R 207

Un'immagine tradizionale carica di atmosfera, che si inserisce perfettamente nell'attuale ricercatezza dell'arredamento moderno. Un disegno di sicuro successo, riprende forme del passato conservandone il senso e arricchendole di finiture ed elementi nuovi e preziosi. La finitura patinata esalta le qualità costruttive degli elementi. Di particolare pregio il panciotto in legno che ospita il lavabo "Luna".

A traditional image full of atmosphere, which fits perfectly in the current research for modern furniture. A surely successful drawing, takes shapes from the past preserving their sense and enriching them with new and precious finishes and elements. The glossy finish exalts the constructive quality of the elements. Particularly precious is the wooden vest holding the "Luna" washbasin.

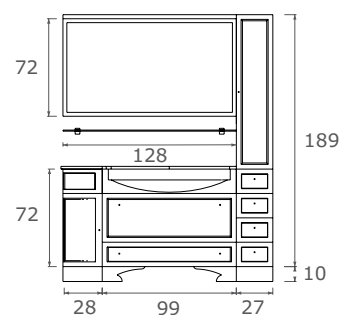

Colore composizione:

Rovere sbiancato patinato (Finitura speciale).

Top in marmo:

Marmo starlight white per lavabo sottopiano "Luna".

Ante, fianchi e cornice specchio:

Massello di rovere.

Cassetto e anta curva:

Massello di rovere.

Strutture interne:

Pannelli idrorepellenti W100 categoria "A".

Composition colour:

Glossy whitened oak (Special finish).

Marble top:

Starlight white marble for the "Luna" undercounter washbasin.

Doors, sides and mirror frame:

Solid oak.

Curved drawer and door:

Solid oak.

Internal structures:

Category "A" W100 water-resistant panels.





RC 01
RC 01



RC 01

Ecco Retrò 01, tante combinazioni di materiali e una grande flessibilità compositiva: top sagomato in quarzo resina bianco polare, frontali, fianchi e specchiera sagomata in legno di rovere decapè azzurro cielo ornata da due eleganti lampade in ottone cromato. I materiali utilizzati sono i più sicuri e le soluzioni d'uso più facili e comode. C'è tutto quello che serve per arredare il tuo bagno: spazio, libertà di movimento, e molta praticità.

Here is Retrò 01, many material combinations and a great composing flexibility: polar white resin quartz shaped top, fronts, sides and shaped mirror in sky blue decapè oak wood decorated with two elegant chrome brass lamps. The materials used are the safest and the use solutions the easiest and most comfortable. There is everything you need to furnish your bathroom: space, freedom of movement, and plenty of practicality.

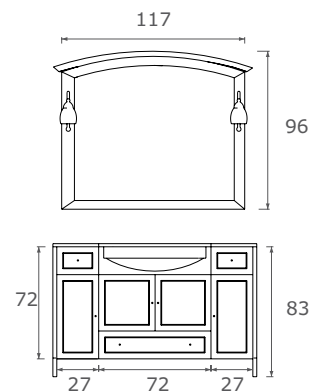

Colore composizione:

Decapè Azzurro cielo (Finitura speciale).

Top in marmo:

Marmo resina bianco polare per lavabo sottopiano Retrò.

Ante, fianchi e cornice specchio:

Massello di rovere.

Panciotto curvo:

Multistrato impiallacciato con legno di rovere.

Strutture interne:

Pannelli idrorepellenti W100 categoria "A".

Composition colour:

Sky blue decapè (Special finish).

Marble top:

Polar white resin marble for Retrò undercounter washbasin.

Doors, sides and mirror frame:

Solid oak.

Curved vest:

Veneered multilayer with oak wood.

Internal structures:

Category "A" W100 water-resistant panels.



RC 02
RC 02

RC 02

Retrò 02 semplifica l'arredamento del bagno con l'obiettivo di ottenere una razionale gestione degli spazi specie se ridotti. La flessibilità dei complementi consente numerose combinazioni. In versione a pavimento con fianchi laterali retrò, si arricchisce di colonna con anta a vetro, mobile portalavabo sottopiano, laccatura anticata grigio cera e specchiera "Master", ricavata dalla fusione di una lastra di vetro sapientemente lavorata da esperte mani artigiane.

Colore composizione:

Anticato Grigio cera (Finitura speciale).

Top in marmo:

Marmo bianco Carrara per lavabo sottopiano Retrò.

Ante e fianchi:

Massello di rovere.

Panciotto curvo:

Multistrato.

Cornice specchio:

Vetro curvato in fusione, sagomato e verniciato.

Strutture interne:

Pannelli idrorepellenti W100 categoria "A".

Retrò 02 simplifies the bathroom furniture with the aim of obtaining a rational management of spaces, especially if reduced. The flexibility of the complements allows for various combinations. In the floor version with retrò sides, it is enriched with a tall unit with glass door, undercounter washbasin unit, wax grey antiqued lacquering and "Master" mirror, obtained by the melting of a glass slab skilfully worked by experienced craftsmen.

Composition colour:

Antiqued wax grey (Special finish).

Marble top:

Carrara white marble for Retrò undercounter washbasin.

Doors and sides:

Solid oak.

Curved vest:

Multilayer.

Mirror frame:

Melted curved glass, shaped and painted.

Internal structures:

Category "A" W100 water-resistant panels.

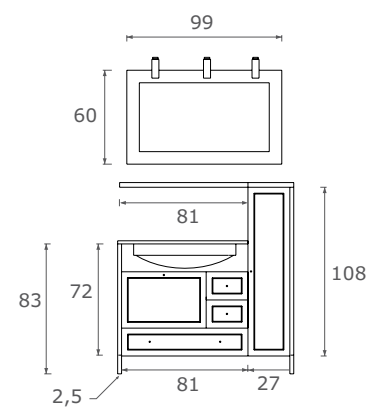



RC 03
RC 03



RC 03

Retrò 03 esprime il fascino di un arredo bagno sempre più pratico e confortevole ma anche fortemente personale. Caratterizzato dal lavabo sottopiano "Enjoy" rettangolare, dal top tecnico "Savana", dalla classicità del rovere tinto noce antico e dalla originale specchiera "Albatros", realizzata artigianalmente e pertanto irripetibile nei suoi dettagli, ci aiuta a vivere meglio gli spazi del quotidiano con una nota di serenità.

Retrò 03 expresses the glamour of an ever practical and comfortable, but also strongly personal, bathroom furniture. Characterised by the rectangular "Enjoy" undercounter washbasin, by the "Savana" technical top, by the classical antique walnut dyed oak and by the original "Albatros" mirror, realised with craftsmanship and, therefore, unrepeatable in its details, helps us live every day spaces better, with a note of harmony.

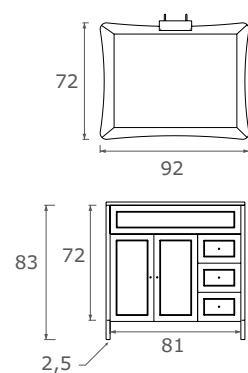

Colore composizione:

Noce (Finitura di base).

Top in marmo:

Marmo tecnico savana per lavabo sottopiano "Enjoy".

Ante e fianchi:

Massello di rovere.

Cornice specchio:

Vetro curvato in fusione, sagomato e verniciato.

Strutture interne:

Pannelli idrorepellenti W100 categoria "A".

Composition colour:

Walnut (Basic finish).

Marble top:

Beige technical marble for "Enjoy" undercounter washbasin.

Doors and sides:

Solid oak.

Mirror frame:

Melted curved glass, shaped and painted.

Internal structures:

Category "A" W100 water-resistant panels.

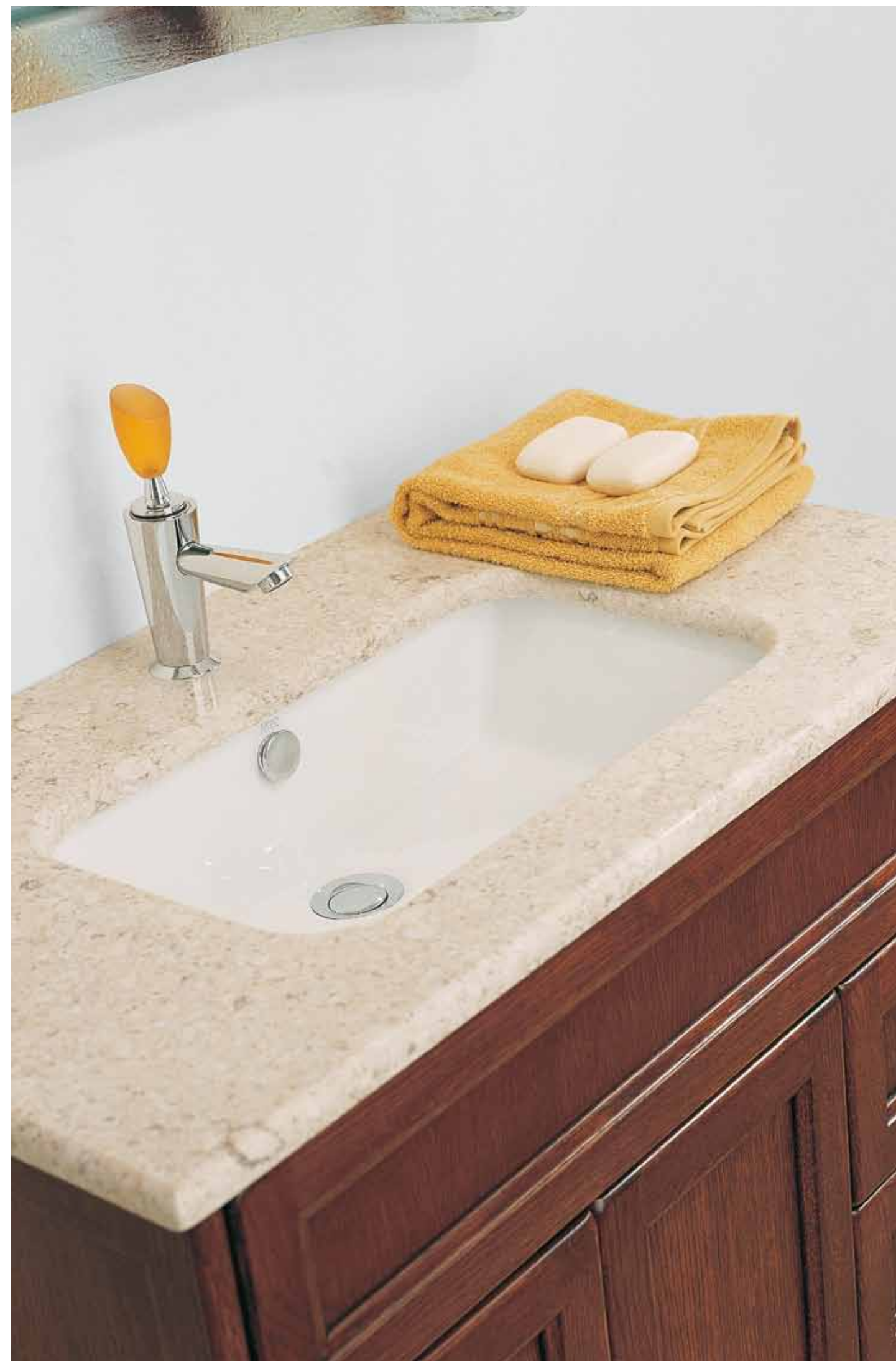



RC 04
RC 04

RC 04

La nuova idea si chiama "Retrò 04", una valida alternativa al classico bagno. Tutti i complementi, il lavabo sottopiano "Luna", l'innovativa fascia Retrò, la base porta lavabo da cm 99 sospesa con ribalta e la colonna da cm 189 sostenuta dal nuovo fianco retrò con piedini a terra, si adattano con flessibilità agli spazi esistenti, grandi o piccoli che siano, per arredare il vostro bagno con creatività.

Colore composizione:

Rovere sbiancato patinato (Finitura speciale).

Top in marmo:

Marmo resina bianco polare per lavabo sottopiano "Luna".

Ante, fianchi e cornice specchio:

Massello di rovere.

Panciotto curvo:

Multistrato impiallacciato con legno di rovere.

Strutture interne:

Pannelli idrorepellenti W100 categoria "A".

The new idea is called "Retrò 04", a valid alternative to the classical bathroom. All complements, the "Luna" undercounter washbasin, the innovative Retrò band, the 99 cm washbasin unit base with flap and the 189 cm tall unit supported by the new retrò side with resting feet, adapt to the flexibility of the existing spaces, large or small, to furnish your bathroom with creativity.

Composition colour:

Glossy whitened oak (Special finish).

Marble top:

Polar white resin marble for "Luna" undercounter washbasin.

Doors, sides and mirror frame:

Solid oak.

Curved vest:

Veneered multilayer with oak wood.

Internal structures:

Category "A" W100 water-resistant panels.

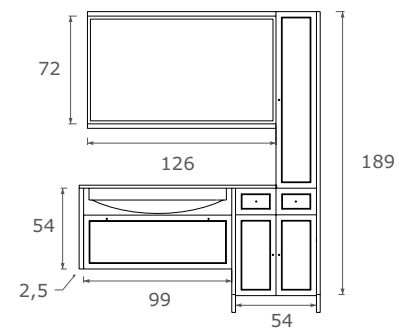



RC 05
RC 05

RC 05

"Nessuna moda da seguire", potrebbe essere il titolo della composizione RC05. In effetti abbiamo volutamente accostato il taglio classico delle specchiere ramate e delle vetrine, alla nuova concezione dei lavabi ad appoggio proponendo così un buon punto di partenza per creare la vostra soluzione "ideale" d'arredo bagno.

Colore composizione:

Bianco avorio decapè, cornice specchio verniciata rame (Finitura speciale).

Top:

Legno impiallacciato rovere per lavabo ad appoggio.

Lavabo:

Ceramica verniciata.

Ante, fianchi e cornice specchio:

Massello di rovere.

Strutture interne:

Pannelli idrorepellenti W100 categoria "A".

"No fashion to follow", could be the title of the RC05 composition. We have, in fact, purposely combined the classical cut of the coppery mirrors and cabinets, to the new conception of surface-mounted washbasins, proposing a good starting point for creating your "ideal" solution of bathroom furniture.

Composition colour:

Ivory white decapè, copper painted mirror frame (Special finish).

Top:

Oak veneered wood for surface-mounted washbasin.

Washbasin:

Painted ceramic.

Doors, sides and mirror frame:

Solid oak.

Internal structures:

Category "A" W100 water-resistant panels.

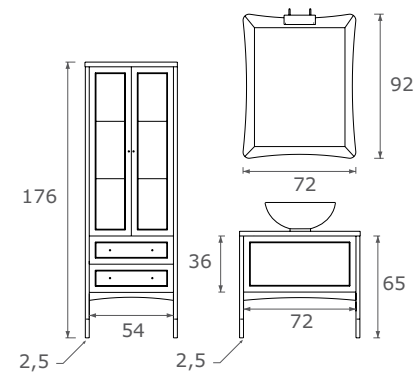



RC 06
RC 06



RC 06

RC 06, ispirato alla contemporaneità, con il suo lavabo sottopiano rettangolare "Gea 90", la specchiera squadrata "Master" in vetro fuso e i 3 faretti con lampada alogena "G9", si fonde con l'eleganza della laccatura anticata color sabbia e con la sobrietà del top tecnico rosa toscana.

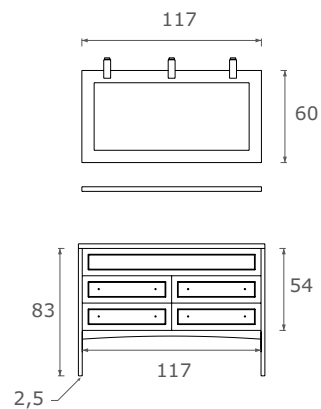

Colore composizione:

Anticato Sabbia (Finitura speciale).

Top in marmo:

Marmo tecnico rosa toscana per lavabo sottopiano "Gea 90".

Ante e fianchi:

Massello di rovere.

Cornice specchio:

Vetro curvato in fusione, sagomato e verniciato.

Strutture interne:

Pannelli idrorepellenti W100 categoria "A".

RC 06, inspired by the contemporaneity, with its "Gea 90" rectangular undercounter washbasin, the "Master" square mirror in melted glass and the 3 spot lights with "G9" halogen lamp, merges with the elegance of the sand antiqued lacquer and with the sobriety of the Tuscany pink technical top.

Composition colour:

Antiqued Sand (Special finish).

Marble top:

Tuscany pink technical marble for "Gea 90" undercounter washbasin.

Doors and sides:

Solid oak.

Mirror frame:

Melted curved glass, shaped and painted.

Internal structures:

Category "A" W100 water-resistant panels.



RC 07
RC 07

RC 07

RC 07, un oggetto che evoca l'antica tradizione del mobile a cassettoni, arricchito dalla specchiera sagomata in massello di rovere, viene rivisto in chiave moderna con il lavabo ad appoggio "Planus ovale" con finitura bucciata e il top in travertino antichizzato.

Colore composizione:

Noce (Finitura di base).

Top in marmo:

Marmo travertino antichato per lavabo ad appoggio "Planus ovale".

Ante, fianchi e cornice specchio:

Massello di rovere.

Strutture interne:

Pannelli idrorepellenti W100 categoria "A".

RC 07, an object that evokes the antique tradition of the large drawer furniture, enriched with the solid oak shaped mirror, is revisited in modern key with the "Planus ovale" surfaced-mounted washbasin with textured finish and antiqued travertino top.

Composition colour:

Walnut (Basic finish).

Marble top:

Antiqued travertino marble for "Planus ovale" surface-mounted washbasin.

Doors, sides and mirror frame:

Solid oak.

Internal structures:

Category "A" W100 water-resistant panels.

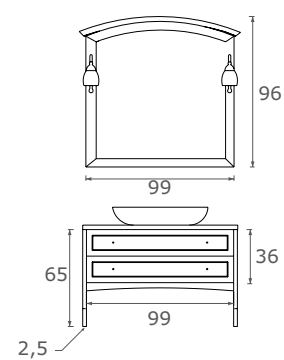



RC 08
RC 08

RC 08

Forme semplici, volumi essenziali e ingombri contenuti, sono le linee guida di RC 08 proposto nella soluzione base portalavabo da cm 72 + base sospesa da cm 36 il tutto sostenuto dai fianchi a terra. Particolare attenzione riveste il nuovo panciotto in legno che si adatta perfettamente alla curva esterna del lavabo sottopiano consentendo di ridurre notevolmente gli spazi di ingombro delle basi portalavabo.

Colore composizione:

Anticato Grigio cera (Finitura speciale).

Top in marmo:

Marmo bianco carrara per lavabo sottopiano Retrò.

Ante, fianchi e cornice specchio:

Massello di rovere.

Panciotto curvo:

Multistrato.

Strutture interne:

Pannelli idrorepellenti W100 categoria "A".

Simple shapes, essential volumes and contained sizes, are the guide lines of RC 08 proposed in the 72 cm washbasin unit base solution + 36 cm suspended base, everything supported by sides resting on the floor. Particular attention covered by the new wooden vest which perfectly adapts to the external curve of the undercounter washbasin allowing significant reduction of overall spaces of the washbasin unit bases.

Composition colour:

Antiqued wax grey (Special finish).

Marble top:

Carrara white marble for Retrò undercounter washbasin.

Doors, sides and mirror frame:

Solid oak.

Curved vest:

Multilayer.

Internal structures:

Category "A" W100 water-resistant panels.

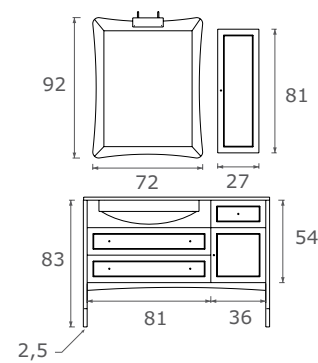



RC 09
RC 09

RC 09

Perfetto è l'equilibrio in questa soluzione gemellare con vasche rettangolari "Enjoy". L'insieme delle due basi assemblate conferisce alla composizione un solido effetto di unico monoblocco sospeso e contenuto da due fianchi a terra speculari e indipendenti. Le specchiere sagomate in massello di rovere si armonizzano con l'intera composizione in tinta noce antico.

Colore composizione:

Noce (finitura di base).

Top in marmo:

Marmo bianco Carrara per lavabo sottopiano "Enjoy".

Ante, fianchi e cornice specchio:

Massello di rovere.

Strutture interne:

Pannelli idrorepellenti W100 categoria "A".

Perfect is the balance in this twin solution with "Enjoy" rectangular basins. The set of the two assembled bases confers a solid effect of a single block composition, suspended and contained by two sides resting on the floor, specular and independent. The shaped solid oak mirrors harmonise with the entire composition in antique walnut dye.

Composition colour:

Walnut (Basic finish).

Marble top:

Carrara white marble for "Enjoy" undercounter washbasin.

Doors, sides and mirror frame:

W100 Water-resistant and MDF panel cat. "A".

Internal structures:

Category "A" W100 water-resistant panels.

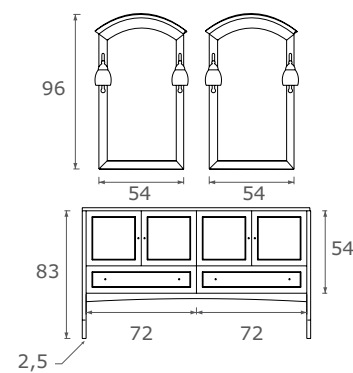



RC 10
RC 10



RC 10

Della composizione RC 10 troviamo tutte le risposte alle diverse esigenze in tema di bagno: funzionalità, componibilità, varietà di colori e di essenze, piani in marmo, in legno e in cristallo colorato. Da notare la versione sospesa senza l'ausilio dei fianchi di riparto laterali che Retrò offre per ogni sua composizione realizzando con piacevolezza, brio e freschezza una nuova generazione di bagni.

Of the RC 10 composition we find all answers to the different requirements with regard to bathroom: functionality, modularity, colour and essences variety, tops in marble, in wood and in coloured crystal. To be noted is the suspended version without the aid of lateral continuation sides that Retrò offers for its every composition realising a new generation of bathrooms with pleasantness, vivacity and freshness.

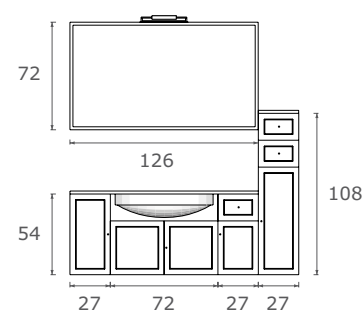

Colore composizione:

Satinato opaco verde cristallo (Finitura speciale).

Top vetro:

Cristallo float colore acquamarina per lavabo sottopiano Retrò.

Ante, fianchi e cornice specchio:

Pannello MDF e idrorepellente W100 categoria "A".

Panciotto curvo:

Multistrato.

Strutture interne:

Pannelli idrorepellenti W100 categoria "A".

Composition colour:

Crystal green matt glazed (Special finish).

Glass top:

Aquamarine float crystal for Retrò undercounter washbasin.

Doors, sides and mirror frame:

Solid oak.

Curved vest:

Multilayer.

Internal structures:

Category "A" W100 water-resistant panels.





RC 11
RC 11

RC 11

Vivere la sala da bagno diventa ogni giorno un dolce piacere grazie ai delicati frontali in rovere sbiancato patinato e alla leggerezza di ante in vetro "canaletto". Il piano in marmo tecnico "rosa toscana" si apre gradevolmente ospitando il lavabo "Luna" che conferisce personalità alla zona del relax quotidiano. Sottostante al piano lavabo, la base da cm 99 nasconde un funzionale cassetto duplex.

Colore composizione:

Rovere sbiancato patinato (Finitura speciale).

Top in marmo:

Marmo tecnico rosa toscana per lavabo sottopiano "Luna".

Ante, fianchi e cornice specchio:

Massello di rovere.

Panciotto curvo:

Multistrato impiallacciato con legno di rovere.

Strutture interne:

Pannelli idrorepellenti W100 categoria "A".

Every day, living the bathroom becomes a pleasure thanks to the delicate glossy whitened oak fronts and the lightness of the "canaletto" glass doors. The "Tuscany pink" technical marble top gradually opens hosting the "Luna" washbasin which confers personality to the daily area of relax. Underneath the washbasin top, the 99 cm base hides a functional duplex drawer.

Composition colour:

Glossy whitened oak (Special finish).

Marble top:

Tuscany pink technical marble for "Luna" undercounter washbasin.

Doors, sides and mirror frame:

Solid oak.

Curved vest:

Veneered multilayer with oak wood.

Internal structures:

Category "A" W100 water-resistant panels.

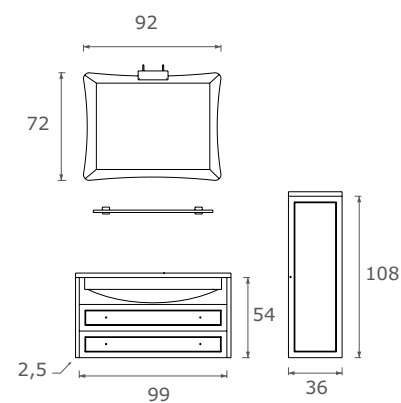



RC 12
RC 12



RC 12

È un bagno raffinato che racchiude in sé tutta la morbida luce del "sabbia antico" e che grazie alla sua linea consente di creare un ambiente completo da vivere ed amare ogni giorno. Di raffinata concezione le ante a telaio e vetro satinato realizzate con il gusto per il dettaglio. Ancora nel segno della funzionalità RC 12 si arricchisce di accessori come l'asta portasciugamani estraibile, una soluzione comoda ed originale.

It is a refined bathroom which encloses the soft light of the "antique sand" and that, thanks to its line, allows creating a complete ambient to live in and love every day. Of refined conception are the frame doors and glazed glass realised with a taste for detail. Still in the sign of functionality, RC 12 enriches itself with accessories like the sliding hand-rail, a comfortable and original solution.

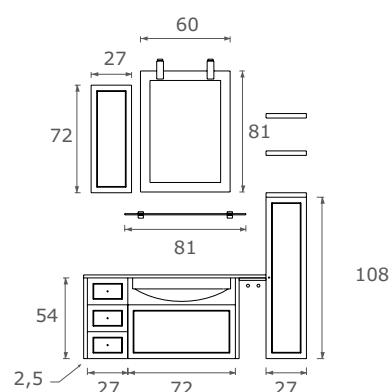

Colore composizione:

Anticato Sabbia (Finitura speciale).

Top in marmo:

Marmo tecnico savana per lavabo sottopiano Retrò.

Ante e fianchi:

Massello di rovere.

Panciotto curvo:

Multistrato.

Cornice specchio:

Vetro curvato in fusione, sagomato e verniciato.

Strutture interne:

Pannelli idrorepellenti W100 categoria "A".

Composition colour:

Antiqued Sand (Special finish).

Marble top:

Beige technical marble for Retrò undercounter washbasin.

Doors and sides:

Solid oak.

Curved vest:

Multilayer.

Mirror frame:

Melted curved glass, shaped and painted.

Internal structures:

Category "A" W100 water-resistant panels.



RC 13
RC 13

RC 13

In una romantica cornice noce antico, trovano il giusto connubio l'elegante specchiera sagomata in massello di rovere con lampade, mensole e l'essenziale base portalavabo sospesa che si adorna del luminoso lavabo ad appoggio "Planus tondo" in ceramica bianca.

The elegant shaped mirror in solid oak with lamps, shelves and the essential suspended washbasin unit base decorated with the luminous "Planus tondo" surface-mounted washbasin in white ceramic, are perfectly combined in a romantic antique walnut frame.

Colore composizione:

Noce (Finitura di base).

Top in marmo:

Marmo tecnico savana per lavabo ad appoggio "Planus".

Ante, fianchi e cornice specchio:

Massello di rovere.

Strutture interne:

Pannelli idrorepellenti W100 categoria "A".

Composition colour:

Walnut (Basic finish).

Marble top:

Beige technical marble for "Planus" surface-mounted washbasin.

Doors, sides and mirror frame:

Solid oak.

Internal structures:

Category "A" W100 water-resistant panels.

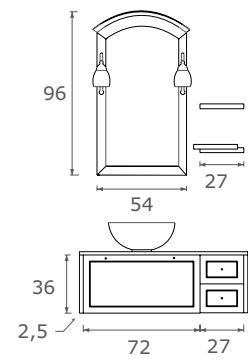



RC 14
RC 14

RC 14

La composizione raccoglie in sé tutti gli elementi indispensabili per trasformare il bagno in un piacere unico da condividere con se stessi grazie al chiarore e alla trasparenza dei frontali in "decapè avorio" e alle giuste proporzioni dei volumi. E' ancora la cura dei particolari a rendere unico il bagno. Lo vediamo dal raffinato accostamento ad "elle" dello specchio contenitore e lo specchio verticale da cm 108.

Colore composizione:

Decapè bianco avorio (Finitura speciale).

Top in marmo:

Marmo tecnico savana per lavabo sottopiano "Enjoy".

Ante, fianchi e cornice specchio:

Massello di rovere.

Strutture interne:

Pannelli idrorepellenti W100 categoria "A".

The composition holds all the essential elements for transforming the bathroom in a unique pleasure, thanks to the lightness and transparency of the fronts in "ivory decapè" and to the right proportions of volumes. Yet again, it's the care taken in the particulars to make the bathroom unique. We can see it from the refined "L" combination of the mirror unit and the 108 cm vertical mirror.

Composition colour:

Ivory white decapè (Special finish).

Marble top:

Beige technical marble for "Enjoy" undercounter washbasin.

Doors, sides and mirror frame:

Solid oak.

Internal structures:

Category "A" W100 water-resistant panels.

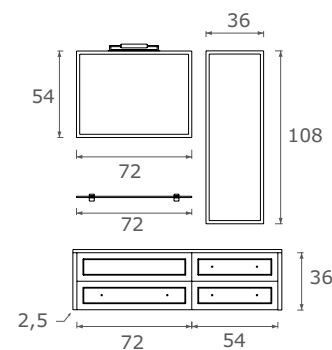



RC 15
RC 15

RC 15

Una composizione che vuole coniugare il tradizionale lavabo semincasso "Genius" in appoggio ad una base portalavabo resa più leggera lateralmente da una postazione ad uso toilette, con una parte superiore più evoluta. L'apertura dell'anta dello specchio contenitore è infatti gestita da un'asta di nuova generazione e dal design innovativo.

Colore composizione:

Bianco avorio decapè (Finitura speciale).

Top in marmo:

Marmo tecnico rosa toscana per lavabo semincasso.

Ante, fianchi e cornice specchio:

Massello di rovere.

Strutture interne:

Pannelli idrorepellenti W100 categoria "A".

A composition wanting to combine the traditional "Genius" semi-recessed surface-mounted washbasin to a washbasin unit base made lighter on the side by a toilette use position, with a more evolved upper part. The opening of the mirror unit door is managed by a new generation rod of innovative design.

Composition colour:

Ivory white decapè (Special finish).

Marble top:

Tuscany pink technical marble for "Genius" undercounter washbasin.

Doors, sides and mirror frame:

Solid oak.

Internal structures:

Category "A" W100 water-resistant panels.

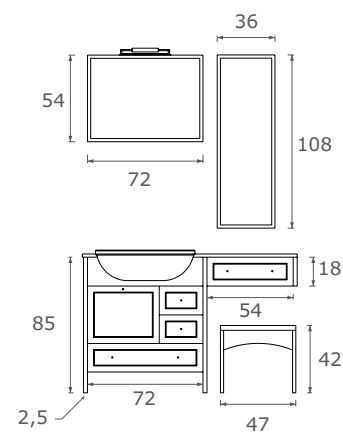

Nelle prossime pagine verranno illustrate alcune composizioni tipo su cui sono state eseguite delle variazioni sul tema principale: questo significa che nel fotografico sarà visualizzata una sola composizione con altri 3 grafici tecnici che metteranno in rilievo la possibilità di ottenere soluzioni alternative con il minimo sforzo e il massimo rendimento.

La nuova linea Retrò pur essendo un ottimo modello di modularità si presta altresì in modo ottimale anche alla praticità della soluzione integrata. Infatti, le tante proposte fotografate e di seguito riportate, vogliono essere un esempio di quanto appena enunciato.

Una soluzione integrata strutturalmente si presenta come un corpo unico indipendente e pronto all'uso senza richiedere laboriose operazioni di assemblaggio. Due sono i caratteri fondamentali di tale composizione:

semplice in quanto sia il rivenditore che l'acquirente finale con pochi ed essenziali articoli sono in grado di realizzare la composizione desiderata, contenuta negli spazi e nei costi. Non ci sarà quindi modo e motivo di inoltrarsi nella "complessità" del componibile perché in poche e semplici pagine saranno racchiuse tutte le informazioni necessarie.

Duttile in quanto si presta molto bene al concetto di "interscambio". A partire da una composizione tipo, c'è la possibilità di creare diverse variazioni sul tema quasi come fosse una sinfonia: al variare di un singolo articolo ne corrisponde una composizione, diversa dalla precedente e mai uguale alla successiva. Ecco allora elevarsi la ricerca dell'armonia tra i componenti che più si adattano alle esigenze personali.

LEGNOBAGNO

Illustrated in the following pages are some composition types on which variations of the main theme have been carried out: this means that the photo will show only one composition with another 3 technical graphs that will highlight the possibility of obtaining alternative solutions with minimum effort and maximum efficiency.

The new Retrò line, although being an optimal model of modularity, is also excellent in terms of the practicality of the integrated solution. In fact, the proposed doors photographed and shown below, want to be an example of that just stated.

A structurally integrated solution is presented as an only body, independent and ready for use, without requiring laborious assembly operations. There are two fundamental features of such composition:

simple in that, both the dealer and the final purchaser with a few essential items are able to realise the wanted composition, contained in spaces and costs. Therefore, there will not be way and reason to go into the "complexity" of the modular as all the necessary information will be enclosed in a few and simple pages.

Ductile in that it is perfect for the "interchange" concept. Starting from a composition type, there is the possibility of creating different variations on the theme, as if it were a symphony: upon the varying of a single item, corresponds to a composition, different from the previous and never the same as the subsequent one. Here arises the research for harmony among the components that better adapt to the personal requirements.

Soluzioni con Top lavabo integrato



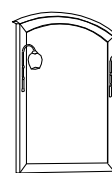

RM31

RM0002
Base p/lavabo integrale L.76 cm 2 ante
1528
Lavabo in ceramica integrale L.78 cm
RS0072
Specchiera sagomata in legno 72 cm
997
N° 2 Lampade Melody cromo

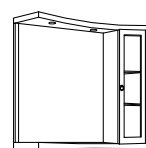
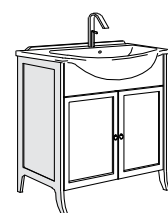

RM 30

RM0001
Base p/lavabo integrale 76 cm 2 ante 3 cassetti
1528
Lavabo in ceramica integrale L.78 cm
RS0072
Specchiera tutto raggio in legno 75 cm

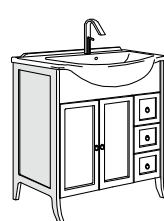

RM 32

RM0001
Base p/lavabo integrale L.76 cm
2 ante 3 cassetti
1528
Lavabo in ceramica integrale L.78 cm
RS0072
Specchiera sagomata in legno 72 cm
997
N° 2 Lampade Melody cromo

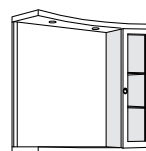
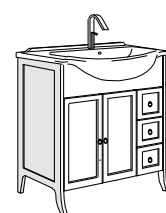

RM 33

RM0002
Base p/lavabo integrale 76 cm 2 ante
1528
Lavabo in ceramica integrale L.78 cm
RS0072
Specchiera tutto raggio in legno 75 cm

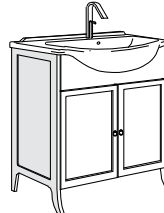

Colore composizione:
Noce (Finitura di base).
Lavabo:
Consolle integrale in ceramica.
Ante, fianchi e cornice specchio:
Massello di rovere.
Strutture interne:
Pannelli idrorepellenti W100 categoria "A".

Composition colour:
Walnut (Basic finish).
Washbasin:
Ceramic integral console.
Doors, sides and mirror frame:
Solid oak.
Internal structures:
Category "A" W100 water-resistant panels.



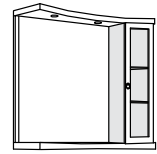

RM 35

RM0003
Base p/lavabo integrale L.76 cm
2 ante 1 cassetto

1528
Lavabo in ceramica integrale L.78 cm

RS0072
Specchiera sagomata in legno 72 cm

997
N° 2 Lampade Melody cromo

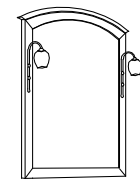
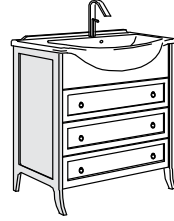

RM 34

RM0004
Base p/lavabo integrale 76 cm 2 ante 1 cassetto duplex

1528
Lavabo in ceramica integrale L.78 cm

RS0072
Specchiera tutto raggio in legno 75 cm

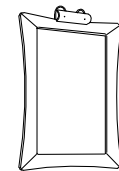
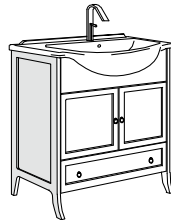

RM 36

RM0003
Base p/lavabo integrale L.76 cm
2 ante 1 cassetto

1528
Lavabo in ceramica integrale L.78 cm

X0691
Specchiera "Albatros" in legno 72 cm

XL005
Lampada "Dafne" cromo

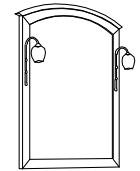

RM 37

RM0004
Base p/lavabo integrale 76 cm 2 cassetti 1 cassetto duplex

1528
Lavabo in ceramica integrale L.78 cm

RS0072
Specchiera tutto raggio in legno 75 cm

997
N° 2 Lampade Melody cromo



Colore composizione:
Anticato Grigio cera (Finitura speciale).

Lavabo:
Consolle integrale in ceramica.

Ante, fianchi e cornice specchio:
Massello di rovere.

Strutture interne:
Pannelli idrorepellenti W100 categoria "A".

Composition colour:
Antiqued wax grey (Special finish).

Washbasin:
Ceramic integral console.

Doors, sides and mirror frame:
Solid oak.

Internal structures:
Category "A" W100 water-resistant panels.



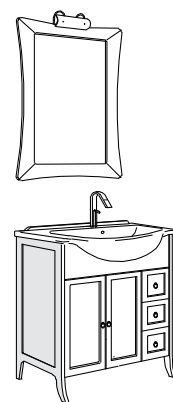

RM 39

RM0001
Base p/lavabo integrale L.76 cm
2 ante 3 cassetti
1528
Lavabo in ceramica integrale L.78 cm
X0691
Specchiera "Albatros" legno 72 cm
XL005
Lampada "Dafne" cromo



RM 38

RM0005
Base p/lavabo integrale L. 76 cm 1 ribalta 1 cassetto
1528
Lavabo in ceramica integrale L.78 cm
X0670
Specchiera "Master" vetro 60 cm
XL005
Lampada "Dafne" cromo
RC1443
Vetrina 1 anta 2 cassetti 42 cm

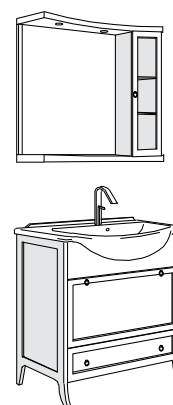

RM 40

RM0005
Base p/lavabo integrale L.76 cm
1 ribalta 1 cassetto
1528
Lavabo in ceramica integrale L.78 cm
RR0072
Specchiera tutto raggio in legno 75 cm

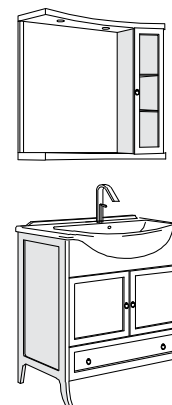

RM 41

RM0003
Base p/lavabo integrale 76 cm 2 ante 1 cassetto
1528
Lavabo in ceramica integrale L.78 cm
RS0072
Specchiera tutto raggio in legno 75 cm

Colore composizione:
Decapè Azzurro cielo (Finitura speciale).
Lavabo:
Consolle integrale in ceramica.
Ante e fianchi:
Massello di rovere.
Cornice specchio:
Vetro curvato in fusione, sagomato e verniciato.
Strutture interne:
Pannelli idrorepellenti W100 categoria "A".

Composition colour:
Sky blue decapè (Special finish).
Washbasin:
Ceramic integral console.
Doors and sides:
Solid oak.
Mirror frame:
Melted curved glass, shaped and painted.
Internal structures:
Category "A" W100 water-resistant panels.



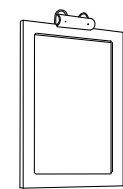

RM 43

RM0007
Base p/lavabo integrale L.76 cm 2 ante
1528
Lavabo in ceramica integrale L.78 cm
X0670
Specchiera "Master" vetro 60 cm
XL005
Lampada "Dafne" cromo

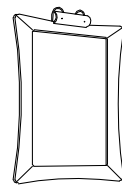

RM 42

RM0006
Base p/lavabo integrale L. 76 cm 1 cassetto
1 cassetto duplex
1528
Lavabo in ceramica integrale L.78 cm
X0691
Specchiera "Albatros" legno 72 cm
XL005
Lampada "Dafne" cromo

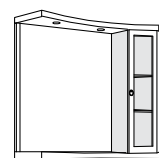

RM 44

RM0006
Base p/lavabo integrale L.76 cm
1 cassetto 1 cassetto duplex
1528
Lavabo in ceramica integrale L.78 cm
RR0072
Specchiera tutto raggio in legno 75 cm

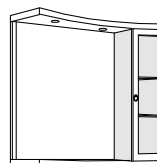

RM 45

RM0007
Base p/lavabo integrale 76 cm 2 ante
1528
Lavabo in ceramica integrale L.78 cm
RS0072
Specchiera tutto raggio in legno 75 cm



Colore composizione:
Noce (Finitura di base).
Lavabo:
Consolle integrale in ceramica.
Ante, fianchi e cornice specchio:
Massello di rovere.
Strutture interne:
Pannelli idrorepellenti W100 categoria "A".

Composition colour:
Walnut (Basic finish).
Washbasin:
Ceramic integral console.
Doors, sides and mirror frame:
Solid oak.
Internal structures:
Category "A" W100 water-resistant panels.



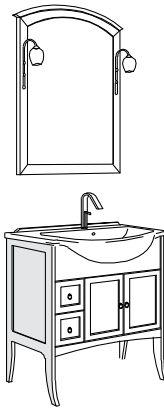

RM 47

RM0009
Base p/lavabo integrale L.76 cm
2 ante 2 cassetti
1528
Lavabo in ceramica integrale L.78 cm
RS0072
Specchiera sagomata in legno 72 cm
997
N° 2 Lampade Melody cromo

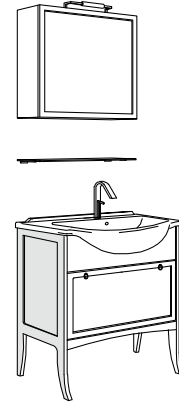

RM 46

RM0008
Base p/lavabo integrale L. 76 cm 1 ribalta
1528
Lavabo in ceramica integrale L.78 cm
X0556
Specchiera Contenitore 72 cm
XV805
Mensola vetro 72 cm
960
Lampada "Genius"

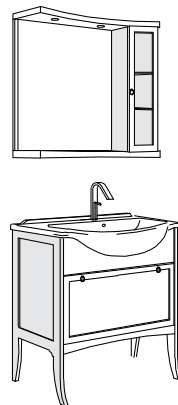

RM 48

RM0008
Base p/lavabo integrale L.76 cm 1 ribalta
1528
Lavabo in ceramica integrale L.78 cm
RR0072
Specchiera tutto raggio in legno 75 cm

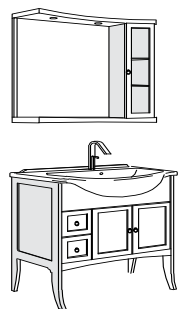

RM 49

RM0009
Base p/lavabo integrale 76 cm 2 ante 2 cassetti
1528
Lavabo in ceramica integrale L.78 cm
RS0072
Specchiera tutto raggio in legno 75 cm

Colore composizione:
Bianco avorio decapè (Finitura speciale).
Lavabo:
Consolle integrale in ceramica.
Ante, fianchi e cornice specchio:
Massello di rovere.
Strutture interne:
Pannelli idrorepellenti W100 categoria "A".

Composition colour:
Ivory white decapè (Special finish).
Washbasin:
Ceramic integral console.
Doors, sides and mirror frame:
Solid oak.
Internal structures:
Category "A" W100 water-resistant panels.

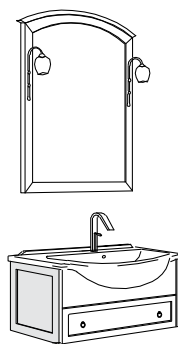

RM 51

RM0010
Base p/lavabo integrale L.76 cm
1 cassetto duplex
1528
Lavabo in ceramica integrale L.78 cm
RS0072
Specchiera sagomata in legno 72 cm
997
N° 2 Lampade Melody cromo

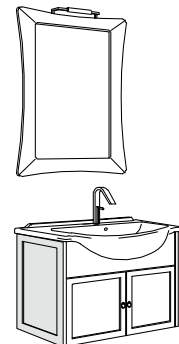

RM 50

RM0007
Base p/lavabo integrale L. 76 cm 2 ante
1528
Lavabo in ceramica integrale L.78 cm
X0691
Specchiera "Albatros" legno 72 cm
960
Lampada "Genius"

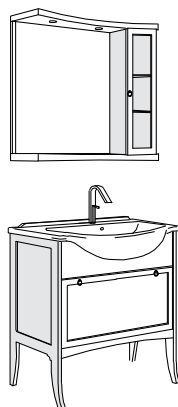

RM 52

RM0008
Base p/lavabo integrale L.76 cm 1 ribalta
1528
Lavabo in ceramica integrale L.78 cm
RR0072
Specchiera tutto raggio in legno 75 cm

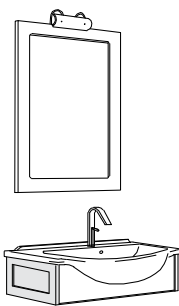

RM 53

RM0011
Base p/lavabo integrale 76 cm
1528
Lavabo in ceramica integrale L.78 cm
X0670
Specchiera "Master" vetro 60 cm
XL005
Lampada "Dafne" cromo

Colore composizione:
Grigio luce (Finitura di base).
Lavabo:
Consolle integrale in ceramica.
Ante, fianchi e cornice specchio:
Massello di rovere.
Strutture interne:
Pannelli idrorepellenti W100 categoria "A".

Composition colour:
Light grey (Basic finish).
Washbasin:
Ceramic integral console.
Doors, sides and mirror frame:
Solid oak.
Internal structures:
Category "A" W100 water-resistant panels.

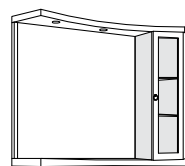

RM 55

RM0013
Base p/lavabo integrale L.86 cm 3 ante
1529
Lavabo in ceramica integrale L.87 cm
RR0081
Specchiera tutto raggio legno L.84 cm

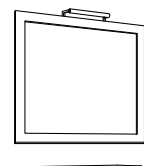

RM 54

RM0012
Base p/lavabo integrale L.86 cm 1 ribalta 3 cassetti
1529
Lavabo in ceramica integrale L.87 cm
X0670
Specchiera "Master" vetro 81 cm
XL006
Lampada "Extreme" 40 cm
XV806
Mensola vetro L.81 cm

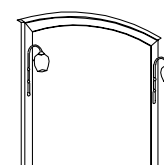
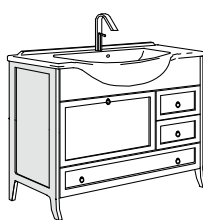

RM 56

RM0012
Base p/lavabo integrale L.86 cm
1 ribalta 3 cassetti
1529
Lavabo in ceramica integrale L.87 cm
RS0081
Specchiera sagomata in legno L.81 cm
997
N° 2 Lampade Melody cromo

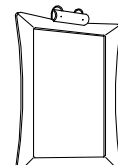

RM 57

RM0013
Base p/lavabo integrale L.86 cm 3 ante
1529
Lavabo in ceramica integrale L.87 cm
X0691
Specchiera "Albatros" legno 72 cm
XL005
Lampada "Dafne" cromo



Colore composizione:
Bianco avorio decapè (Finitura speciale).
Lavabo:
Consolle integrale in ceramica.
Ante, fianchi:
Massello di rovere.
Cornice specchio:
Vetro curvato in fusione, sagomato e verniciato.
Strutture interne:
Pannelli idrorepellenti W100 categoria "A".

Composition colour:
Ivory white decapè (Special finish).
Washbasin:
Ceramic integral console.
Doors, sides:
Solid oak.
Mirror frame:
Melted curved glass, shaped and painted.
Internal structures:
Category "A" W100 water-resistant panels.

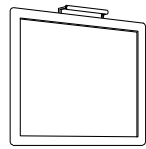

RM 59

RM0015
Base p/lavabo integrale L.86 cm
2 cassetti 1 cassetto duplex

1529
Lavabo in ceramica integrale L.87 cm
X0670
Specchiera "Master" vetro 81 cm
XL006
Lampada "Extreme" 40 cm

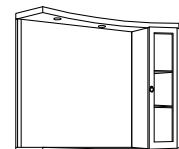

RM 58

RM0014
Base p/lavabo integrale L.86 cm 3 cassetti 2 ante

1529
Lavabo in ceramica integrale L.87 cm
RR0081
Specchiera tutto raggio legno L.84 cm

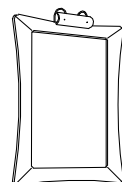
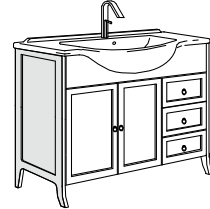

RM 60

RM0014
Base p/lavabo integrale L.86 cm
3 cassetti 2 ante

1529
Lavabo in ceramica integrale L.87 cm
X0691
Specchiera "Albatros" legno 72 cm
XL005
Lampada "Dafne" cromo

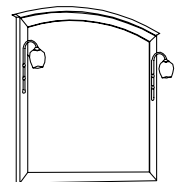

RM 61

RM0015
Base p/lavabo integrale L.86 cm 2 cassetti
1 cassetto duplex

1529
Lavabo in ceramica integrale L.87 cm
RS0081
Specchiera sagomata in legno 81 cm
997
N° 2 Lampade Melody cromo



Colore composizione:
Decapè Rosa (Finitura speciale).
Lavabo:
Consolle integrale in ceramica.
Ante, fianchi e cornice specchio:
Massello di rovere.
Strutture interne:
Pannelli idrorepellenti W100 categoria "A".

Composition colour:
Pink Decapè (Special finish).
Washbasin:
Ceramic integral console.
Doors, sides and mirror frame:
Solid oak.
Internal structures:
Category "A" W100 water-resistant panels.



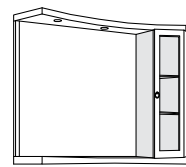

RM 63

RM0017
Base p/lavabo integrale L.86 cm
1 ribalta 1 cassetto
1529
Lavabo in ceramica integrale L.87 cm
RR0081
Specchiera tutto raggio legno L.84 cm

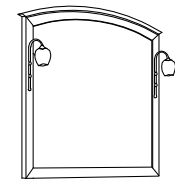
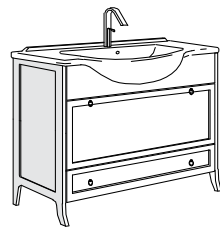

RM 62

RM0016
Base p/lavabo integrale L.86 cm 1 cassetto 3 ante
1529
Lavabo in ceramica integrale L.87 cm
RR0081
Specchiera tutto raggio legno L.84 cm
997
N° 2 Lampade Melody cromo

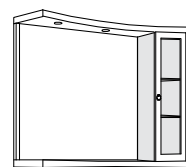
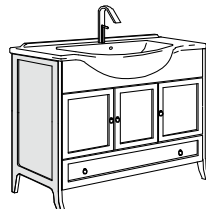

RM 64

RM0016
Base p/lavabo integrale L.86 cm
1 cassetto 3 ante
1529
Lavabo in ceramica integrale L.87 cm
RS0081
Specchiera sagomata in legno 81 cm

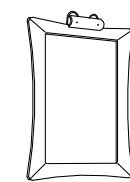
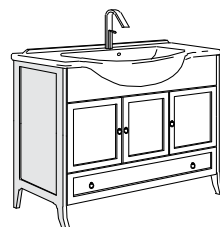

RM 65

RM0017
Base p/lavabo integrale L.86 cm 1 ribalta 1 cassetto
1529
Lavabo in ceramica integrale L.87 cm
X0691
Specchiera "Albatros" legno 72 cm
XL005
Lampada "Dafne" cromo

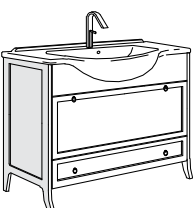

Colore composizione:
Anticato Verde (Finitura speciale).
Lavabo:
Consolle integrale in ceramica.
Ante, fianchi e cornice specchio:
Massello di rovere.
Strutture interne:
Pannelli idrorepellenti W100 categoria "A".

Composition colour:
Antiqued Green (Special finish).
Washbasin:
Ceramic integral console.
Doors, sides and mirror frame:
Solid oak.
Internal structures:
Category "A" W100 water-resistant panels.



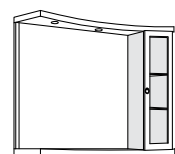

RM 67

RM0019
Base p/lavabo integrale L.86 cm 1 ribalta
1529
Lavabo in ceramica integrale L.87 cm
RR0081
Specchiera tutto raggio legno L.84 cm

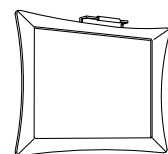
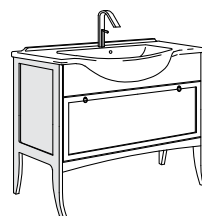

RM 66

RM0018
Base p/lavabo integrale L.86 cm 1 cassetto
1 cassetto duplex
1529
Lavabo in ceramica integrale L.87 cm
X0691
Specchiera "Albatros" legno 92 cm
960
Lampada "Genius"

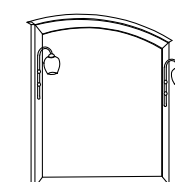
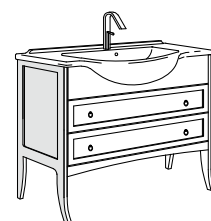

RM 68

RM0020
Base p/lavabo integrale L.86 cm 3 ante
1529
Lavabo in ceramica integrale L.87 cm
RS0081
Specchiera sagomata in legno 81 cm
997
N° 2 Lampade Melody cromo

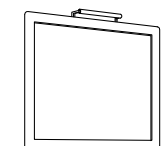
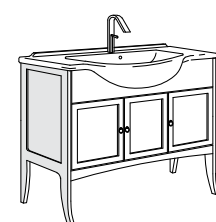

RM 69

RM0021
Base p/lavabo integrale L.86 cm 1 ribalta 2 cassetti
1529
Lavabo in ceramica integrale L.87 cm
X0670
Specchiera "Master" vetro 81 cm
XL006
Lampada "Extreme" 40

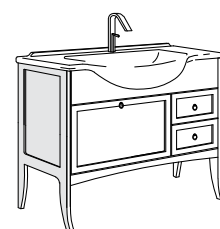

Colore composizione:
Decapè Turchese (Finitura speciale).
Lavabo:
Consolle integrale in ceramica.
Ante, fianchi e cornice specchio:
Massello di rovere.
Strutture interne:
Pannelli idrorepellenti W100 categoria "A".

Composition colour:
Turquoise Decapè (Special finish).
Washbasin:
Ceramic integral console.
Doors, sides and mirror frame:
Solid oak.
Internal structures:
Category "A" W100 water-resistant panels.



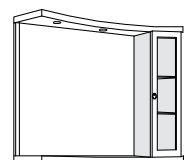

RM 71

RM0020
Base p/lavabo integrale L.86 cm 3 ante
1529
Lavabo in ceramica integrale L.87 cm
RR0081
Specchiera tutto raggio legno L.84 cm

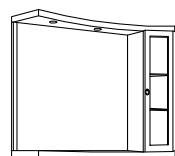
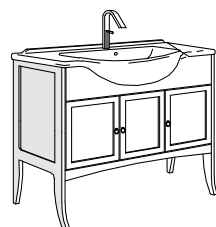

RM 70

RM0022
Base p/lavabo integrale L.86 cm 2 ante 2 cassetti
1529
Lavabo in ceramica integrale L.87 cm
RR0081
Specchiera tutto raggio legno L.84 cm



RM 72

RM0022
Base p/lavabo integrale L.86 cm 3 ante
1529
Lavabo in ceramica integrale L.87 cm
X0691
Specchiera "Albatros" legno 72 cm
XL005
Lampada "Dafne" cromo

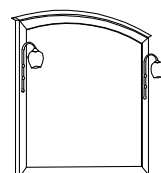

RM 73

RM0041
Base p/lavabo integrale L.86 cm 1 ribalta 2 cassetti
1529
Lavabo in ceramica integrale L.87 cm
RR0081
Specchiera tutto raggio legno L.84 cm
997
N° 2 Lampade Melody cromo

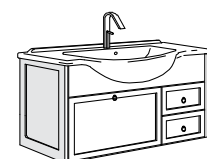

Colore composizione:
Anticato Grigio cera (Finitura speciale).
Lavabo:
Consolle integrale in ceramica.
Ante, fianchi e cornice specchio:
Massello di rovere.
Strutture interne:
Pannelli idrorepellenti W100 categoria "A".

Composition colour:
Antiqued wax grey (Special finish).
Washbasin:
Ceramic integral console.
Doors, sides and mirror frame:
Solid oak.
Internal structures:
Category "A" W100 water-resistant panels.



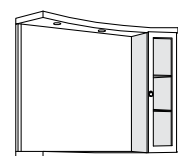

RM 75

RM0041
Base p/lavabo integrale L.86 cm 1 ribalta
2 cassetti



1529
Lavabo in ceramica integrale L.87 cm
RR0081
Specchiera tutto raggio legno L.84 cm

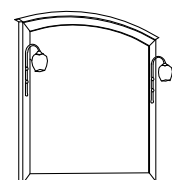

RM 74

RM0042
Base p/lavabo integrale L.86 cm 2 ante 2 cassetti
1529

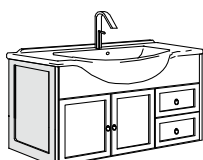

Lavabo in ceramica integrale L.87 cm
RR0081
Specchiera tutto raggio legno L.84 cm
997
N° 2 Lampade Melody cromo

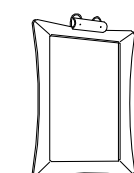

RM 76

RM0042
Base p/lavabo integrale L.86 cm
2 ante 2 cassetti



1529
Lavabo in ceramica integrale L.87 cm
X0691
Specchiera "Albatros" legno 72 cm
XL005
Lampada "Dafne" cromo

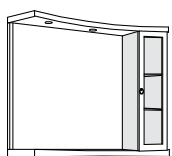

RM 77

RM0042
Base p/lavabo integrale L.86 cm 2 ante 2 cassetti
1529

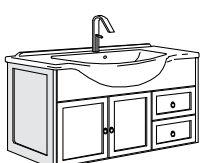

Lavabo in ceramica integrale L.87 cm
RR0081
Specchiera tutto raggio legno L.84 cm

Colore composizione:
Anticato Sabbia (Finitura speciale).
Lavabo:
Consolle integrale in ceramica.
Ante, fianchi e cornice specchio:
Massello di rovere.
Strutture interne:
Pannelli idrorepellenti W100 categoria "A".

Composition colour:
Antiqued Sand (Special finish).
Washbasin:
Ceramic integral console.
Doors, sides and mirror frame:
Solid oak.
Internal structures:
Category "A" W100 water-resistant panels.



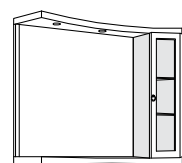

RM 79

RM0020
Base p/lavabo integrale L.86 cm 3 ante
1529

Lavabo in ceramica integrale L.87 cm

RR0081
Specchiera tutto raggio legno L.84 cm

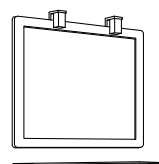

RM 78

RM0043
Base p/lavabo integrale L.86 cm 1 cassetto
1 cassetto duplex

1529
Lavabo in ceramica integrale L.87 cm

X0670
Specchiera "Master" vetro 81 cm

XV806
Mensola vetro 81 cm

XL001
N°2 Faretti "Form"

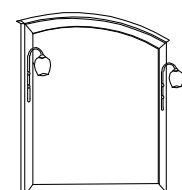
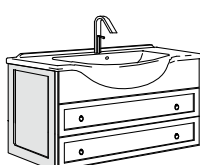

RM 80

RM0043
Base p/lavabo integrale L.86 cm
1 cassetto 1 cassetto duplex

1529
Lavabo in ceramica integrale L.87 cm

RR0081
Specchiera tutto raggio legno L.84 cm

997
N° 2 Lampade Melody cromo

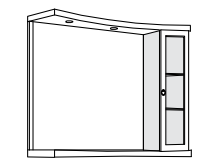
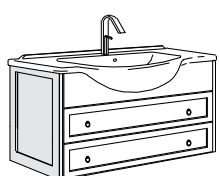

RM 81

RM0019
Base p/lavabo integrale L.86 cm 1 ribalta

1529
Lavabo in ceramica integrale L.87 cm

RR0081
Specchiera tutto raggio legno L.84 cm

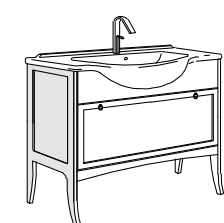

Colore composizione:
Decapè Azzurro cielo (Finitura speciale).

Lavabo:
Consolle integrale in ceramica.

Ante, fianchi e cornice specchio:
Massello di rovere.

Cornice specchio:
Vetro curvato in fusione, sagomato e verniciato.

Strutture interne:
Pannelli idrorepellenti W100 categoria "A".

Composition colour:
Sky blue decapè (Special finish).

Washbasin:
Ceramic integral console.

Doors, sides and mirror frame:
Solid oak.

Mirror frame:
Melted curved glass, shaped and painted.

Internal structures:
Category "A" W100 water-resistant panels.



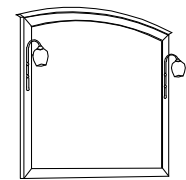

RM 83

RM0024
Base p/lavabo integrale L.104 cm
2 ante 3 cassetti
1538
Lavabo in ceramica integrale L.105 cm
RS0099
Specchiera sagomata in legno 99 cm
997
N° 2 Lampade Melody cromo

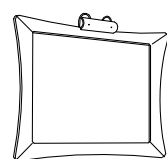

RM 82

RM0023
Base p/lavabo integrale L.104cm 1 cassetto 1 ribalta
1538
Lavabo in ceramica integrale L.105 cm
X0691
Specchiera "Albatros" 92 cm
XL005
Lampada "Dafne" cromo

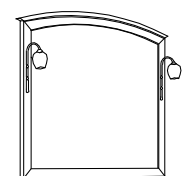
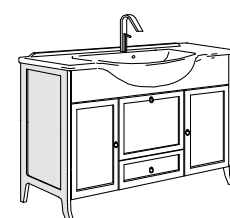

RM 84

RM0023
Base p/lavabo integrale L.104 cm
2 ante 1 cassetto 1 ribalta
1538
Lavabo in ceramica integrale L.105 cm
RS0099
Specchiera sagomata in legno 99 cm
997
N° 2 Lampade Melody cromo

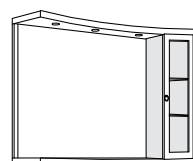
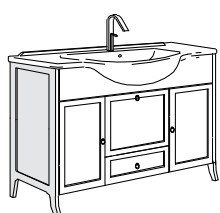

RM 85

RM0024
Base p/lavabo integrale L104 cm 2 ante 3 cassetti
1538
Lavabo in ceramica integrale L.105 cm
RS0099
Specchiera sagomata in legno 99 cm

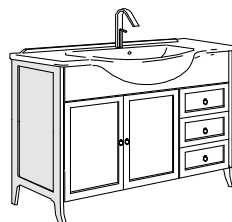

Colore composizione:
Noce (Finitura di base).
Lavabo:
Consolle integrale in ceramica.
Ante, fianchi e cornice specchio:
Massello di rovere.
Strutture interne:
Pannelli idrorepellenti W100 categoria "A".

Composition colour:
Walnut (Basic finish).
Washbasin:
Ceramic integral console.
Doors, sides and mirror frame:
Solid oak.
Internal structures:
Category "A" W100 water-resistant panels.



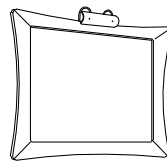

RM 87

RM0026
Base p/lavabo integrale L.104 cm 3 ante
1538
Lavabo in ceramica integrale L.105 cm
X0691
Specchiera "Albatros" 92 cm
XL005
Lampada "Dafne" cromo

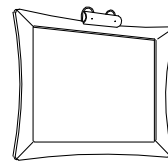
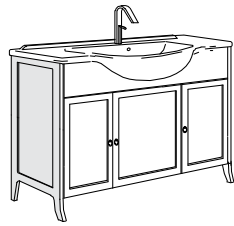

RM 86

RM0025
Base p/lavabo integrale L.104cm 1 cassetto 1 ribalta
1538
Lavabo in ceramica integrale L.105 cm
RS0099
Specchiera sagomata in legno 99 cm
997
N° 2 Lampade Melody cromo

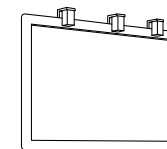
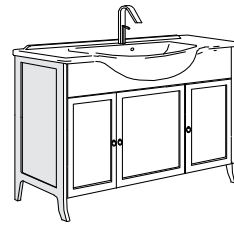

RM 88

RM0027
Base p/lavabo integrale L.104 cm
1 ribalta 3 cassetti
1538
Lavabo in ceramica integrale L.105 cm
X0671
Specchiera "Master" vetro 99 cm
XL001
N°3 Faretti "Form"

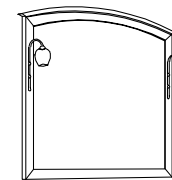
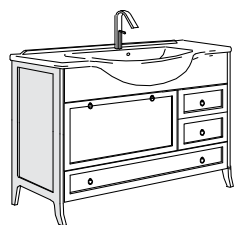

RM 89

RM0028
Base p/lavabo integrale L.104 cm
2 cassetti 1 cassetto duplex
1538
Lavabo in ceramica integrale L.105 cm
RS0099
Specchiera sagomata in legno 99 cm
997
N° 2 Lampade Melody cromo

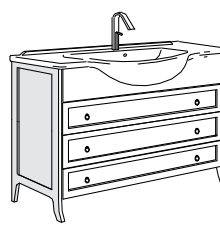

Colore composizione:
Rovere sbiancato patinato (Finitura speciale).
Lavabo:
Consolle integrale in ceramica.
Ante, fianchi e cornice specchio:
Massello di rovere.
Strutture interne:
Pannelli idrorepellenti W100 categoria "A".

Composition colour:
Glossy whitened oak (Special finish).
Washbasin:
Ceramic integral console.
Doors, sides and mirror frame:
Solid oak.
Internal structures:
Category "A" W100 water-resistant panels.



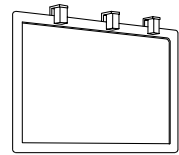

RM 91

RM0030
Base p/lavabo integrale L.104 cm 1 ribalta
1538
Lavabo in ceramica integrale L.105 cm
X0671
Specchiera "Master" vetro 99 cm
XL001
N°3 Faretti "Form"

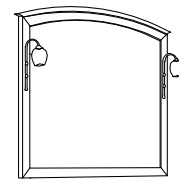
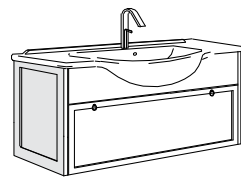

RM 90

RM0029
Base p/lavabo integrale L.104cm 2 cassetti 1 ribalta
1538
Lavabo in ceramica integrale L.105 cm
RS0099
Specchiera sagomata in legno 99 cm
997
N° 2 Lampade Melody cromo

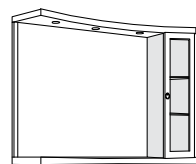
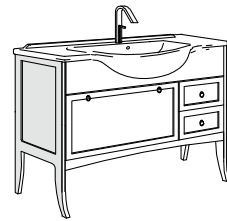

RM 92

RM0029
Base p/lavabo integrale L.104 cm
1 ribalta 2 cassetti
1538
Lavabo in ceramica integrale L.105 cm
RS0099
Specchiera sagomata in legno 99 cm

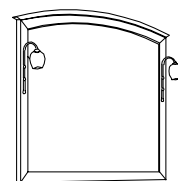
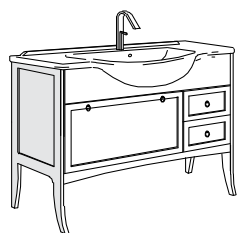

RM 93

RM0031
Base p/lavabo integrale L.104 cm
1 cassetto 1 cassetto duplex
1538
Lavabo in ceramica integrale L.105 cm
RS0099
Specchiera sagomata in legno 99 cm
997
N° 2 Lampade Melody cromo

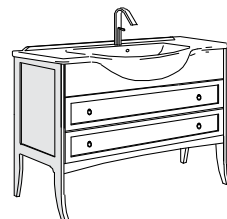

Colore composizione:
Decapè Verde acqua (Finitura speciale).
Lavabo:
Consolle integrale in ceramica.
Ante, fianchi e cornice specchio:
Massello di rovere.
Strutture interne:
Pannelli idrorepellenti W100 categoria "A".

Composition colour:
Antiqued Water Green (Special finish).
Washbasin:
Ceramic integral console.
Doors, sides and mirror frame:
Solid oak.
Internal structures:
Category "A" W100 water-resistant panels.



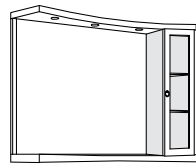

RM 95

RM0027
Base p/lavabo integrale L.104 cm
1 ribalta 3 cassetti

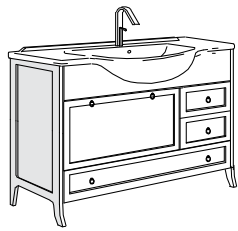

1538
Lavabo in ceramica integrale L.105 cm
RR0099
Specchiera tutto raggio legno 102 cm

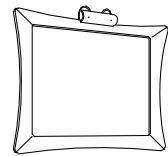

RM 94

RM0030
Base p/lavabo integrale L.104cm 1 ribalta

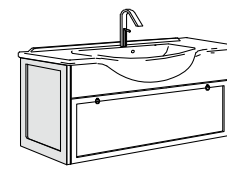

1538
Lavabo in ceramica integrale L.105 cm
X0691
Specchiera "Albatros" finitura colore rame 92 cm
XL005
Lampada "Dafne" cromo

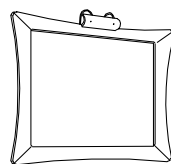

M 96

RM0029
Base p/lavabo integrale L.104 cm
1 ribalta 2 cassetti

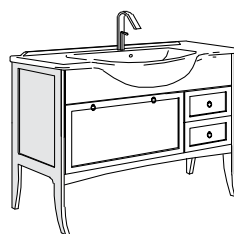

1538
Lavabo in ceramica integrale L.105 cm
X0691
Specchiera "Albatros" legno 92 cm
XL005
Lampada "Dafne" cromo

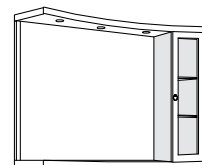

RM 97

RM0032
Base p/lavabo integrale L104 cm 3 ante



1538
Lavabo in ceramica integrale L.105 cm
RS0099
Specchiera sagomata in legno 99 cm

Colore composizione:
Noce (Finitura di base), cornice specchio verniciata rame (Finitura speciale).

Lavabo:
Consolle integrale in ceramica.
Ante, fianchi e cornice specchio:
Massello di rovere.
Strutture interne:
Pannelli idrorepellenti W100 categoria "A".

Composition colour:
Walnut (Basic finish), copper painted mirror frame (Special finish).

Washbasin:
Ceramic integral console.
Doors, sides and mirror frame:
Solid oak.
Internal structures:
Category "A" W100 water-resistant panels.



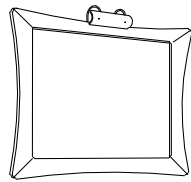

RM 99

RM0034
Base p/lavabo integrale L.104 cm
1 cassetto duplex

1538
Lavabo in ceramica integrale L.105 cm
X0691
Specchiera "Albatros" legno 92 cm
XL005
Lampada "Dafne" cromo

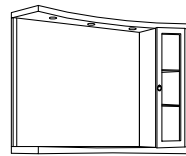
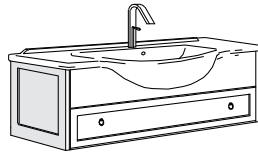

RM 98

RM0033
Base p/lavabo integrale L.104cm 2 ante 1 ribalta

1538
Lavabo in ceramica integrale L.105 cm
RR0099
Specchiera tutto raggio legno 102 cm

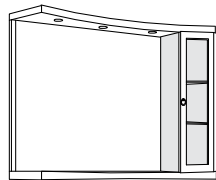
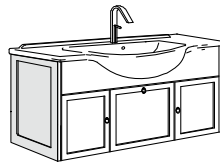

RM 100

RM0034
Base p/lavabo integrale L.104 cm
1 cassetto duplex

1538
Lavabo in ceramica integrale L.105 cm
RS0099
Specchiera sagomata in legno 99 cm

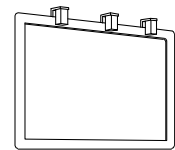
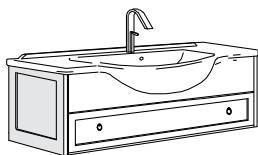

RM 101

RM0031
Base p/lavabo integrale L.104 cm
1 cassetto 1 cassetto duplex

1538
Lavabo in ceramica integrale L.105 cm
X0671
Specchiera "Master" vetro 99 cm
XL001
N°3 Faretti "Form"

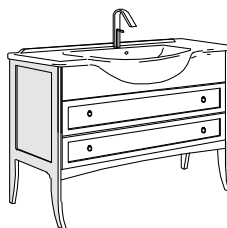

Colore composizione:
Rovere miele (Finitura speciale).
Lavabo:
Consolle integrale in ceramica.
Ante, fianchi e cornice specchio:
Massello di rovere.
Strutture interne:
Pannelli idrorepellenti W100 categoria "A".

Composition colour:
Honey oak (Special finish).
Washbasin:
Ceramic integral console.
Doors, sides and mirror frame:
Solid oak.
Internal structures:
Category "A" W100 water-resistant panels.



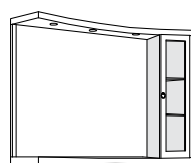

RM 103

RM0036
Base p/lavabo integrale L.122 cm
2 ante 1 cassetto 1 ribalta
1539
Lavabo in ceramica integrale L.123 cm
RR0117
Specchiera Tutto raggio legno 120 cm

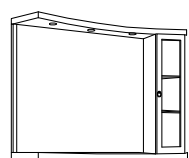
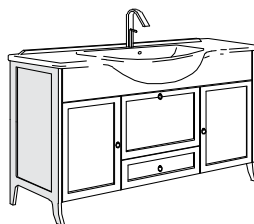

RM 102

RM0035
Base p/lavabo integrale L.122cm
2 ante 2 cassetti 1 ribalta
1539
Lavabo in ceramica integrale L.105 cm
RR0117
Specchiera Tutto raggio legno 120 cm

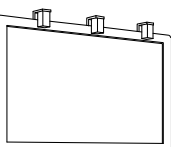
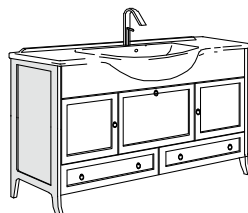

RM 104

RM0035
Base p/lavabo integrale L.122 cm
2 ante 2 cassetti 1 ribalta
1539
Lavabo in ceramica integrale L.123 cm
X0672
Specchiera "Master" vetro 117 cm
XL001
N°3 Faretti "Form"

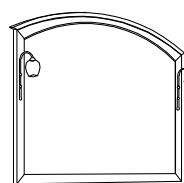
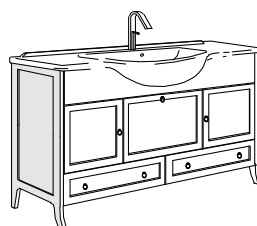

RM 105

RM0036
Base p/lavabo integrale L.122 cm
2 ante 1 cassetto 1 ribalta
1539
Lavabo in ceramica integrale L.123 cm
RS0117
Specchiera sagomata in legno 117 cm
997
N° 2 Lampade Melody cromo

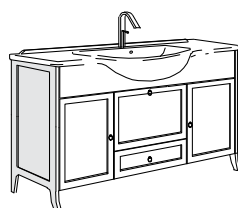

Colore composizione:
Noce (Finitura di base).
Lavabo:
Consolle integrale in ceramica.
Ante, fianchi e cornice specchio:
Massello di rovere.
Strutture interne:
Pannelli idrorepellenti W100 categoria "A".

Composition colour:
Walnut (Basic finish).
Washbasin:
Ceramic integral console.
Doors, sides and mirror frame:
Solid oak.
Internal structures:
Category "A" W100 water-resistant panels.



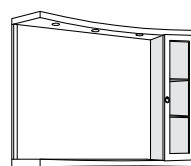

RM 107

RM0038
Base p/lavabo integrale L. 122 cm
2 ante 1 cassetto
1539
Lavabo in ceramica integrale L. 123 cm
RR0117
Specchiera Tutto raggio legno 120 cm

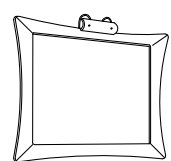
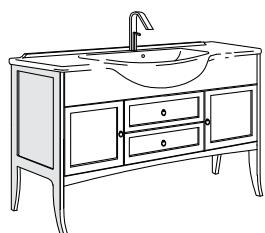

RM 106

RM0037
Base p/lavabo integrale L. 122cm 2 ante 1 ribalta
1539
Lavabo in ceramica integrale L. 105 cm
X0691
Specchiera "Albatros" legno 92 cm
XL005
Lampada "Dafne" cromo
XV806
Mensola vetro 81 cm

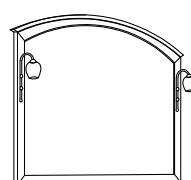
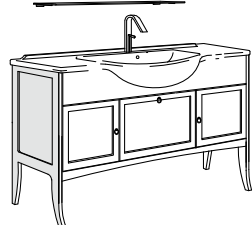

RM 108

RM0037
Base p/lavabo integrale L. 122 cm
2 ante 1 ribalta
1539
Lavabo in ceramica integrale L. 123 cm
RS0117
Specchiera sagomata in legno 117 cm
997
N° 2 Lampade Melody cromo

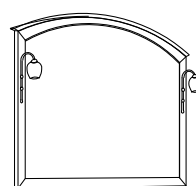
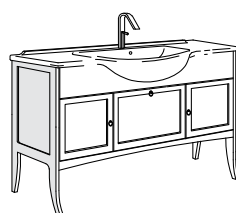

RM 109

RM0039
Base p/lavabo integrale L. 122 cm 4 cassetti
1539
Lavabo in ceramica integrale L. 123 cm
RS0117
Specchiera sagomata in legno 117 cm
997
N° 2 Lampade Melody cromo



Colore composizione:
Bianco opaco (Finitura speciale).
Lavabo:
Consolle integrale in ceramica.
Ante, fianchi e cornice specchio:
Massello di rovere.
Strutture interne:
Pannelli idrorepellenti W100 categoria "A".

Composition colour:
Matt white (Special finish).
Washbasin:
Ceramic integral console.
Doors, sides and mirror frame:
Solid oak.
Internal structures:
Category "A" W100 water-resistant panels.



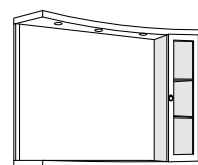

RM 111

RM0040
Base p/lavabo integrale L.122 cm
2 cassetti
1539
Lavabo in ceramica integrale L.123 cm
RR0117
Specchiera Tutto raggio legno 120 cm

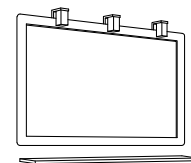

RM 110

RM0039
Base p/lavabo integrale L.122cm 4 cassetti
1539
Lavabo in ceramica integrale L.105 cm
X0672
Specchiera "Master" vetro 117 cm
RC0810
Mensola legno 117 cm
XL001
N°3 Faretto "Form"

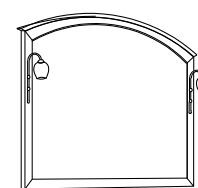

RM 112

RM0039
Base p/lavabo integrale L.122 cm
4 cassetti
1539
Lavabo in ceramica integrale L.123 cm
RS0117
Specchiera sagomata in legno 117 cm
997
N° 2 Lampade Melody cromo

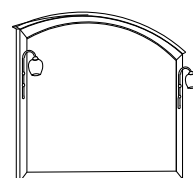

RM 113

RM0038
Base p/lavabo integrale L.122 cm 2 ante 1 cassetto
1539
Lavabo in ceramica integrale L.123 cm
RS0117
Specchiera sagomata in legno 117 cm
997
N° 2 Lampade Melody cromo

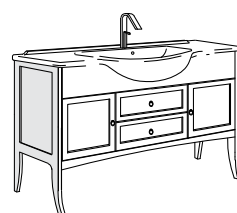

Colore composizione:
Anticato Sabbia (Finitura speciale).
Lavabo:
Consolle integrale in ceramica.
Ante, fianchi e cornice specchio:
Massello di rovere.
Strutture interne:
Pannelli idrorepellenti W100 categoria "A".

Composition colour:
Antiqued Sand (Special finish).
Washbasin:
Ceramic integral console.
Doors, sides and mirror frame:
Solid oak.
Internal structures:
Category "A" W100 water-resistant panels.



Accessori



Serie completa di accessori in legno massello realizzata in modo tipicamente artigianale. Questi accessori, perfettamente coordinabili ai mobili, possono essere realizzati nelle stesse colorazioni: decapè, anticati e satinati.

Series complete of accessories in solid wood realised in a typically craftsmanship manner. These accessories, that can be perfectly coordinated with the furniture, can be realised in the same colouring: decapè, antiqued and glazed.



Portacarta COD. 0903

Portascopino COD. 0904



Portasciugamani anello COD. 0908





Portasapone COD. 0900



Portabicchiere COD. 0901



Appendino COD. 0902



Portasciugamani L43 cm COD. 0906 - L58 cm COD.0907



Lampada a parete COD. 0910

Alcuni particolari come il portabicchiere, il portasapone, le aste portasalviette e le applique a parete. Le lampade sono disponibili in tre finiture: cromo bronzo e oro.

Some particulars like the cup holder, the soap dish, the towel rack rods and the wall applique. The lamps are available in three finishes: chrome, bronze and gold.



Design
Studio Legnobagno

Foto e Grafica
Studio21

Stampa
Telligraf

Ringraziamenti
disegno ceramica

www.legnobagno.it
LEGNOBAGNO®

LEGNOBAGNO

LEGNOBAGNO®

STABILIMENTO PRODUTTIVO

Via Alfredo Fieramonti (Zona Industriale) 04012 Cisterna di Latina (LT)

Tel: 06.9680943 - Fax: 06.9680948

Web: www.legnobagno.it E-mail: info@legnobagno.it