

STABILIMENTO PRODUTTIVO  
Via Alfredo Fieramonti (Zona Industriale)  
04012 Cisterna di Latina (LT)  
Tel: +39.06.9680943  
Fax: +39.06.9680948  
Web: www.legnobagno.it  
Email: info@legnobagno.it

**FLEX-03**  
Express

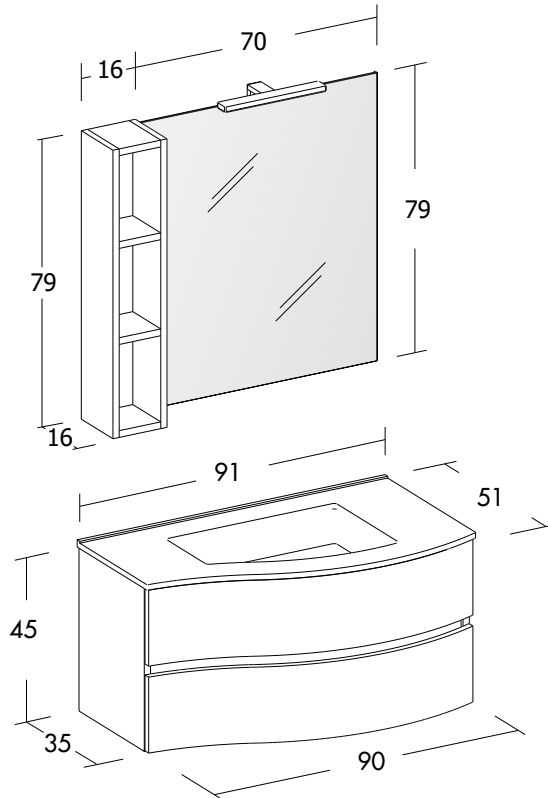

SCHEDA TECNICA  
TECHNICAL SHEET

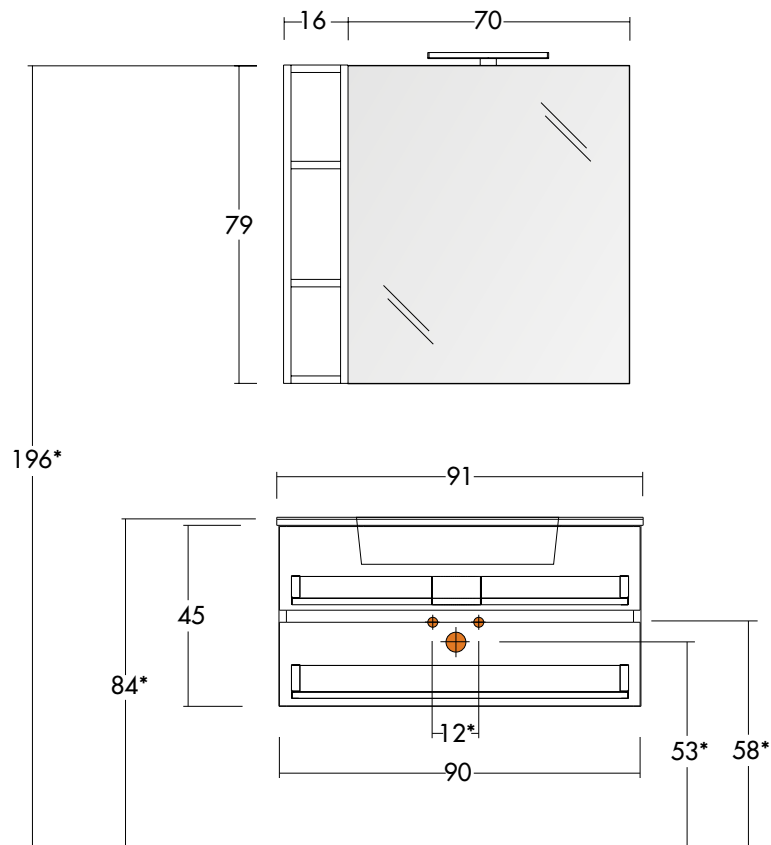

\*quote di installazione consigliate  
\*assembly dimensions recommended