

STABILIMENTO PRODUTTIVO  
Via Alfredo Fieramonti (Zona Industriale)  
04012 Cisterna di Latina (LT)  
Tel: +39.06.9680943  
Fax: +39.06.9680948  
Web: [www.legnobagno.it](http://www.legnobagno.it)  
Email: [info@legnobagno.it](mailto:info@legnobagno.it)

**COMPONIBILE\_4**  
Urban

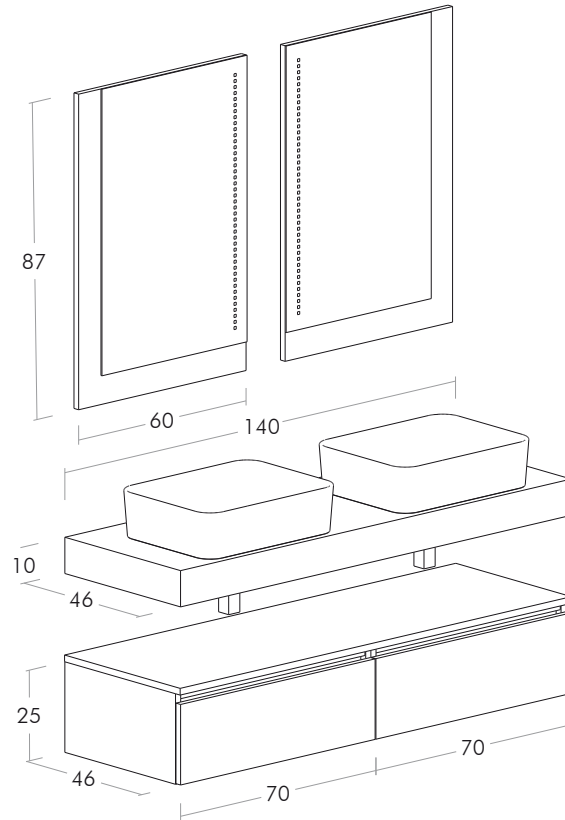

**SCHEDA TECNICA**  
TECHNICAL SHEET

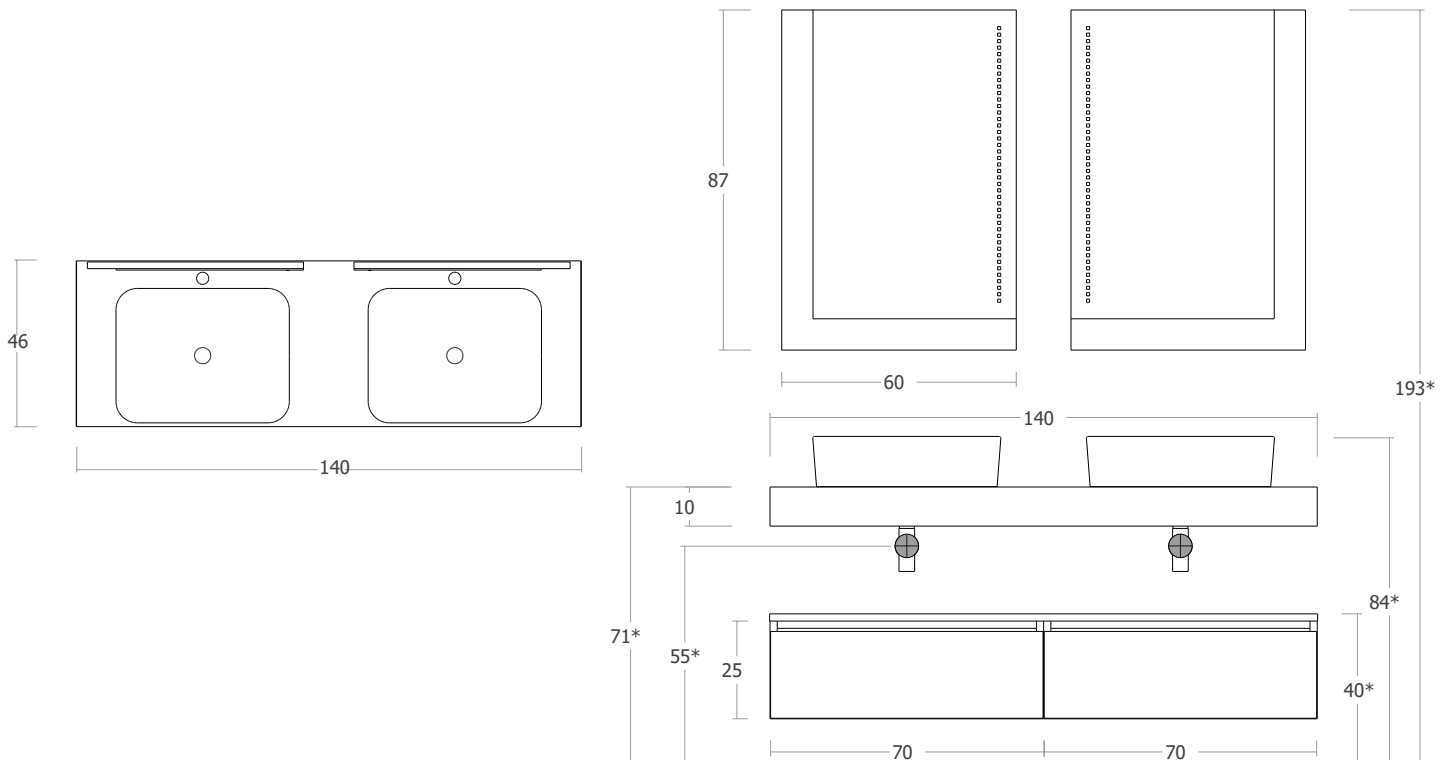

\*quote di installazione consigliate  
\*assembly dimensions recommended